

# TOSHIBA

## Blu-ray Disc Player **BDX2500KU**

### OWNER'S MANUAL



- INTRODUCTION
- CONNECTIONS
- PLAYBACK
- FUNCTION SETUP
- OTHERS

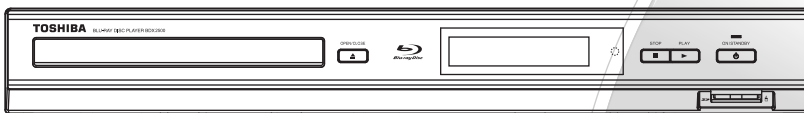

#### Owner's Record

The model number and serial number are on the back of this unit. Record these numbers in the spaces below. Refer to these numbers whenever you communicate with your Toshiba dealer about this unit.

Model number:

Serial number :

# SAFETY PRECAUTIONS

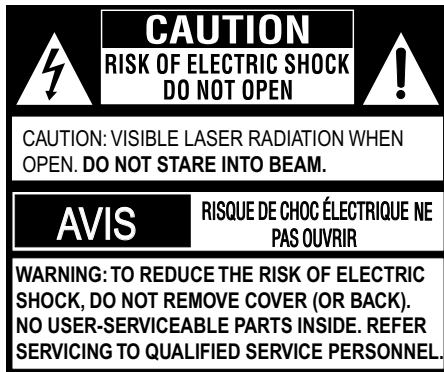

The lightning flash with an arrowhead symbol, within the equilateral triangle, is intended to alert the user to the presence of uninsulated "dangerous voltage" within the product's enclosure that may be of sufficient magnitude to constitute a risk of electric shock to persons.



The exclamation point within the equilateral triangle is intended to alert the user to the presence of important operating and maintenance (servicing) instructions in this owner's manual.

**WARNING:** TO REDUCE THE RISK OF FIRE OR ELECTRIC SHOCK, DO NOT EXPOSE THIS APPLIANCE TO RAIN OR MOISTURE. DANGEROUS HIGH VOLTAGES ARE PRESENT INSIDE THE ENCLOSURE. DO NOT OPEN THE CABINET. REFER SERVICING TO QUALIFIED PERSONNEL ONLY.



The symbol for Class II (Double Insulation)

# IMPORTANT SAFETY INSTRUCTIONS

1. Read these instructions.
2. Keep these instructions.
3. Heed all warnings.
4. Follow all instructions.
5. Do not use this apparatus near water.
6. Clean only with a dry cloth.
7. Do not block any of the ventilation openings. Install in accordance with the manufacturer's instructions.
8. Do not install near any heat sources such as radiators, heat registers, stoves, or other apparatus (including amplifiers) that produce heat.
9. Do not defeat the safety purpose of the polarized or grounding-type plug. A polarized plug has two blades with one wider than the other. A grounding type plug has two blades and a third grounding prong. The wide blade or the third prong is provided for your safety. If the provided plug does not fit into your outlet, consult an electrician for replacement of the obsolete outlet.
10. Protect the power cord from being walked on or pinched particularly at plugs, convenience receptacles, and the point where they exit from the apparatus.
11. Only use attachments/accessories specified by the manufacturer.
12. Use only with the cart, stand, tripod, bracket, or table specified by the manufacturer, or sold with the apparatus. When a cart is used, use caution when moving the cart/apparatus combination to avoid injury from tip-over.
13. Unplug this apparatus during lightning storms or when unused for long periods of time.
14. Refer all servicing to qualified service personnel. Servicing is required when the apparatus has been damaged in any way, such as the power-supply cord or plug is damaged, liquid has been spilled or objects have fallen into the apparatus, the apparatus has been exposed to rain or moisture, does not operate normally, or has been dropped.



# ADDITIONAL SAFETY INSTRUCTIONS

15. Do not overload wall outlets; extension cords, or integral convenience receptacles as this can result in a risk of fire or electric shock.
16. Apparatus shall not be exposed to dripping or splashing and no objects filled with liquids, such as vases, shall be placed on the apparatus.
17. Keep your fingers well clear of the disc tray as it is closing. Neglecting to do so may cause serious personal injury.
18. Do not place a heavy object on or step on the apparatus. The object may fall, causing serious personal injury and serious damage to the apparatus.
19. Do not use a cracked, deformed, or repaired disc. These discs are easily broken and may cause serious personal injury and apparatus malfunction.
20. If the apparatus should emit smoke or an unusual odor, immediately disconnect the power cord from the wall outlet. Wait until the smoke or smell stops, then ask your dealer for a check and repair. Neglecting to do so may cause fire.
21. During thunderstorms, do not touch the connecting cables or the apparatus.
22. Warning: To prevent spread of fire, keep candles or other open flames away from this product at all times.
23. The mains plug is used as disconnect device. The mains plug of apparatus should not be obstructed OR should be easily accessed during intended use. To be completely disconnect the power input, the mains plug of apparatus shall be disconnected from the mains.

# PRECAUTIONS

## CAUTION:

- To prevent direct exposure to laser beam, do not try to open the enclosure. Visible and invisible laser radiation when open and interlocks defeated. DO NOT STARE INTO BEAM.
- Use of controls or adjustments or performance of procedures other than those specified may result in hazardous radiation exposure.
- Danger of explosion if battery is incorrectly replaced. Replace only with the same or equivalent type.

**Warning:** Batteries shall not be exposed to excessive heat such as sunshine, fire or the like.

## FCC Information

This device complies with Part 15 of the FCC Rules. Operation is subject to the following two conditions: (1) this device may not cause harmful interference, and (2) this device must accept any interference received, including interference that may cause undesired operation.

The party responsible for compliance to these rules is:  
Toshiba America Consumer Products, L.L.C.  
82 Totowa Rd. Wayne, NJ 07470.  
Ph: 1-800-631-3811

**Note:** This equipment has been tested and found to comply with the limits for a Class B digital device, pursuant to part 15 of the FCC Rules. These limits are designed to provide reasonable protection against harmful interference in a residential installation. This equipment generates, uses, and can radiate radio frequency energy and, if not installed and used in accordance with the instructions, may cause harmful interference to radio communications.

However, there is no guarantee that interference will not occur in a particular installation. If this equipment does cause harmful interference to radio or television reception, which can be determined by turning the equipment off and on, the user is encouraged to try to correct the interference by one or more of the following measures:

- Reorient or relocate the receiving antenna.
- Increase the separation between the equipment and receiver.
- Connect the equipment into an outlet on a circuit different from that to which the receiver is connected.
- Consult the dealer or an experienced radio/TV technician for help.

**This class B digital apparatus complies with Canadian ICES-003.**

**Cet appareil numérique de la classe B est conforme à la norme NMB-003 du Canada.**

**WARNING:** Changes or modifications to this unit not expressly approved by Toshiba, or parties authorized by Toshiba, could void the user's authority to operate the equipment.

## Notes On Copyright

This product incorporates copyright protection technology that is protected by U.S. patents and other intellectual property rights. Use of this copyright protection technology must be authorized by Rovi Corporation, and is intended for home and other limited viewing uses only unless otherwise authorized by Rovi Corporation. Reverse engineering or disassembly is prohibited.

## On Placement

- Do not use this unit in places which are extremely hot, cold, dusty or humid.
- Do not restrict the air flow of this unit by placing it somewhere with poor air flow, by covering it with a cloth, or by placing it on bedding or carpeting.
- Be sure to remove the disc and unplug the AC power cord from the outlet before carrying the unit.

## On Safety

- Do not handle the AC power cord with wet hands and do not put your fingers or objects into the unit.
- When connecting or disconnecting the AC power cord, grip the plug and not the cord itself. Pulling the cord may damage it and create a hazard.
- When you are not going to use the unit for a long period of time, disconnect the AC power cord.

## On Condensation

- When left in a heated room where it is warm and damp, water droplets or condensation may form inside the equipment. When there is condensation inside the unit, the unit may not function normally. Let the unit stand for 1-2 hours before turning the power on or gradually heat the room and allow the unit to dry before use.

## On Recycling

- This unit's packaging materials are recyclable and can be reused. Please dispose of any materials in accordance with your local recycling regulations.
- Batteries should never be thrown away or incinerated but disposed of in accordance with your local regulations concerning chemical wastes.



## Supplied Accessories



Remote Control with Batteries (AAA x 2)

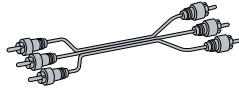

Composite Audio / Video Cables

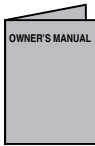

Owner's Manual (EN)



Quick Start Guide (EN/ES)

## Symbols used in this Manual

To specify for which media type each function is, we put the following symbols at the beginning of each item to operate.

Symbol	Description
	Description refers to BD-video and BD-RE / BD-R recorded in BDMV format
	Description refers to DVD-video
	Description refers to Audio CD / DTS-CD
	Description refers to DVD-RW/-R with AVCHD files
	Description refers to BD-RE/-R, DVD-RW/-R, CD-RW/-R and SD Memory Card with MP3 files
	Description refers to BD-RE/-R, DVD-RW/-R, CD-RW/-R and SD Memory Card with Windows Media™ Audio files
	Description refers to BD-RE/-R, DVD-RW/-R, CD-RW/-R and SD Memory Card with JPEG files

If you do not find any of the symbols listed above under the function heading, the operation is applicable to all media.

## Trademark Information

“Blu-ray Disc” and are trademarks of Blu-ray Disc Association.

Blockbuster is a registered trademark of Blockbuster, Inc.

Netflix is a registered trademark of Netflix Inc.

Pandora is a registered trademark of Pandora Media, Inc.

VUDU is a trademark of VUDU, Inc.

	“DVD” is a trademark of DVD Format / Logo Licensing Corporation.
	HDMI, the HDMI logo, and High-Definition Multimedia Interface are trademarks or registered trademarks of HDMI Licensing LLC in the United States and other countries.
	Manufactured under license from Dolby Laboratories. Dolby and the double-D symbol are trademarks of Dolby Laboratories.
	Manufactured under license under U.S. Patent #'s: 5,451,942; 5,956,674; 5,974,380; 5,978,762; 6,226,616; 6,487,535; 7,392,195; 7,272,567; 7,333,929; 7,212,872 & other U.S. and worldwide patents issued & pending. DTS and the Symbol are registered trademarks, & DTS-HD, DTS-HD Master Audio   Essential and the DTS logos are trademarks of DTS, Inc. Product includes software. © DTS, Inc. All Rights Reserved.
	“x.v.Color” and “x.v.Color” logo are trademarks of Sony Corporation.
	“AVCHD” and the “AVCHD” logo are trademarks of Panasonic Corporation and Sony Corporation.
	“BONUSVIEW” is trademark of Blu-ray Disc Association.
	Java and all other Java trademarks and logos are trademarks or registered trademarks of Sun Microsystems, Inc. in the United States and/or other countries.
	“BD-LIVE” logo is trademark of Blu-ray Disc Association.
	Windows Media and the Windows logo are trademarks or registered trademarks of Microsoft Corporation in the United States and/or other countries.

# Table of Contents

## Introduction

- SAFETY PRECAUTIONS ..... 2
- IMPORTANT SAFETY INSTRUCTIONS ..... 2
- PRECAUTIONS ..... 3
- Supplied Accessories ..... 4
- Symbols used in the Manual ..... 4
- Trademark Information ..... 4
- Table of Contents ..... 5
- Features ..... 6
- Identification of Controls ..... 7
  - Front panel ..... 7
  - Rear panel ..... 7
- Using the Remote Control ..... 8
  - Remote Control ..... 8
  - Installing batteries ..... 9
  - Operating with the remote control ..... 10
  - Front Panel Display ..... 10

## Connections

- Connecting to a TV ..... 11
  - Connecting to a TV using an HDMI cable ..... 12
  - Connecting to a TV using a component video ..... 12
  - Connecting to a TV using an A/V cable ..... 12
- Connecting to an Audio System ..... 13
  - Via 2-Channel Analog Audio Output ..... 13
  - Via Digital Audio Output ..... 13
  - Via HDMI Audio Output ..... 13
- Wired Network Connection ..... 14
  - Connecting your player to a wired router ..... 14
- Wireless Network Connection ..... 15
- Connecting the Speakers ..... 16
- Positioning the Speakers ..... 17

## Playback

- Information on Playback ..... 18
  - Playable Discs and Files ..... 18
  - Unplayable Discs and Files ..... 18
  - Color Systems ..... 19
  - Region Codes ..... 19
  - Structure of Disc/SD Card Contents ..... 19
- Playing a Disc ..... 20
  - Basic playback ..... 20
- Variable Speed Playback ..... 21
  - Playing in fast reverse / forward directions ..... 21
  - Playing frame by frame ..... 21
  - Playing in slow motion ..... 21
- Locating a Desired Section ..... 21
  - Locating a title using the top menu ..... 21
  - Locating a specific chapter or track ..... 22

- Accessing a Specific Location Directly ..... 22
  - Locating a specific title/chapter/time ..... 22
- Repeating a Title, Chapter, Track or Specific Segment ..... 23
  - Repeating a title, chapter or track ..... 23
  - Repeating a specific segment ..... 23
- Playing in a Random Order ..... 23
  - Playing tracks or files in a random order ..... 23
- PIP(BONUSVIEW) Setting ..... 24
- Camera Angle ..... 24
- Audio Selection ..... 24
- Subtitle Selection ..... 25
- Displaying On-screen Information ..... 25
- Playing AVCHD/MP3/WMA/JPEG Files ..... 26
  - Playing files on a data disc ..... 26
- Using an SD Card ..... 27
  - Inserting an SD card ..... 27
- Using a USB Device ..... 28
  - Operating a USB device ..... 28

## Customizing the Function Settings

- General Operations ..... 29
- Network Connection Setting ..... 29
- Info Menu ..... 29
- Performing Quick-Setup ..... 29
- Display Setting ..... 30
- Audio Setting ..... 31
- Speaker Setting ..... 32
- Language Setting ..... 33
- Parental Control ..... 33
- System Setting ..... 34
- Upgrading Your Player's Firmware ..... 35
- Using the Connected Applications ..... 36
  - Watching movies with Netflix™ ..... 36
  - Watching movies with Blockbuster® ..... 37
  - Watching movies with VUDU™ ..... 37
  - Listening to music with Pandora™ ..... 38
- Using BD-Live™ Features ..... 38

## Others

- Troubleshooting & Maintenance ..... 39
  - Troubleshooting ..... 39
  - Maintenance ..... 40
- Glossary ..... 41
- Specifications ..... 43
- Limited Warranty ..... 44

## Features

### Blu-ray Disc

You can enjoy Blu-ray Disc which is capable of storing five times more data than a conventional DVD.

### BD-Java

With some BDs which support Java applications, you can enjoy the interactive functions such as games or interactive menus.

### BD-Live

BD-Live (BD-ROM version 2 Profile 2.0) that allows interactive functions to be used when this unit is connected to the Internet in addition to the BONUSVIEW function. The various functions differ depending on the disc.

### Full high-definition video playback

Watch movies in the highest picture quality available for your HDTV. This unit offers full high-definition video playback up to 1080p resolution for an amazing viewing experience. A highly detailed picture and increased sharpness delivers a more true-to-life picture.

### DVD Upconversion for enhanced picture quality

Your current DVD will look even better than before thanks to video upconversion. Upconversion will increase the resolution of standard definition DVD to high definition up to 1080p over an HDMI connection. The picture will be less jagged and more realistic for a near high-definition experience.

### Enjoy your content on different kinds of media

Full backwards compatibility with BD, DVD, CD and SD card ensures that you can continue to enjoy your current audio-video collection. Additionally, you can view JPEG digital pictures or listen to MP3 or Windows Media™ Audio music files.

### Experience rich multi-channel surround sound

Multi-channel surround sound, which recognizes real-to-life sound and makes you feel like you are really there.

### PIP (BONUSVIEW)

Some BD-videos have the PIP function which enables you to display the secondary video in the primary video. You can call up the secondary video by pressing **BONUSVIEW** whenever the scene contains the secondary video.

### Pop-up menu

Some BD-video have pop-up menu which is a navigation menu that can be called up and be operated on the TV screen without interrupting the playback. You can call up the pop-up menu by pressing **POPOP/TOP MENU** or **MENU**. Contents in the pop-up menu vary depending on the disc.

### Playback of Content from an SD Memory Card

You can play back MP3 / WMA / JPEGs stored in an SD Memory Card. You can store picture-in-picture commentary, subtitles or other extras for BD-ROM ver. 2 (Profile 2.0 / Profile 1.1) files in an SD Memory Card and play back with the BD-video.

### Playing back AVCHD files

This unit supports playback of AVCHD format files (new format for high definition video camcorders) recorded on disc. Your high definition personal archive is playable in HD quality.

### x.v.Color

This unit supports playback of video contents on discs recorded with "x.v.Color" technology. To watch this video content with the "x.v.Color", a TV or other display device supporting both video image reproduction using the "x.v.Color" standard and capable of manually switching its color setting is required. Please refer to the owner's manual of your display device for further information.

### Easy and simple connection to your HDTV via HDMI

Connect this unit to your HDTV with one single HDMI (High-Definition Multimedia Interface) cable. It is recommended to use a High Speed HDMI Cable for better compatibility. The high definition video output signal will be transferred to your HDTV without conversion to analog signals, so you will get excellent picture and sound quality.

Thanks to other multiple outputs, you can also easily connect to your home theater system or amplifier.

### HDMI CEC (Consumer Electronics Control)

This unit supports HDMI CEC, which allows integrated system control over HDMI and is part of the HDMI standard.

This function may not work properly on some devices.

### HDMI 1080p/24F output (BD only)

This unit is equipped with a feature which can provide the smooth movement in the playback of film originated material with the frame rate of 24 frames per second with progressive scan. (Available only when the TV is connected by an HDMI cable and compatible with 1080p/24F frame input.)

Refer to "Display Setting" in "Customizing the Function Settings" on page 30.

### Copyright protection system

To play back the digital video images of a BD / DVD via an HDMI connection, it is necessary that both the unit and the TV (or an AV amplifier) support a copyright protection system called HDCP (high-bandwidth digital content protection system). HDCP is copy protection technology that comprises data encryption and authentication of the connected AV device. This unit supports HDCP. Please read the operating instructions of your TV (or AV amplifier) for more information.

# Identification of Controls

## Front panel

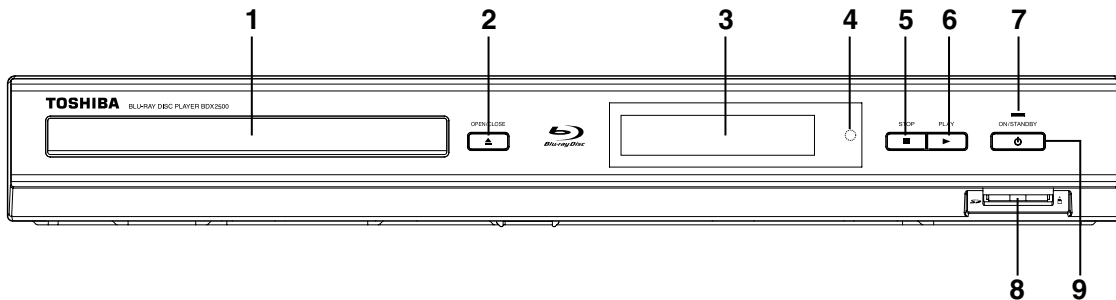

Introduction

1. **Disc tray**
2. **OPEN/CLOSE** button
3. **Display**
  - Refer to “Front Panel Display” on page 10.
4. **Remote sensor**
5. **STOP** button
6. **PLAY** button
7. **ON/STANDBY indicator**
8. **SD card slot**
9. **ON/STANDBY button**
  - Press to turn on the unit, or to turn the unit into the standby mode. (To completely turn off the unit, you must unplug the AC power cord.)

## Rear panel

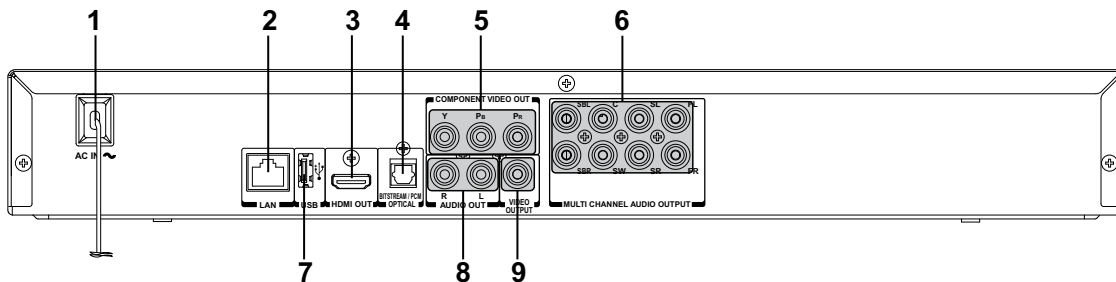

1. **AC power cord**
  - Connect to a standard AC outlet to supply power to this unit.
  - Unplug this cord from the AC outlet to completely turn off the unit.
2. **LAN terminal**
  - Use to connect a network equipment with LAN cable.
3. **HDMI OUT jack**
  - Use to connect a TV with an HDMI compatible port via an HDMI cable.
4. **OPTICAL jack**
  - Use to connect an AV receiver / amplifier, Dolby Digital / DTS decoder or other device with a digital audio optical input jack using a digital audio optical cable.
5. **COMPONENT VIDEO OUT jacks**
  - Use to connect a TV with component video inputs using a component video cable.
6. **MULTI CHANNEL AUDIO OUTPUT jacks**
  - Use to connect an AV receiver / amplifier with a audio cable.
7. **USB jack**
  - Use to connect USB flash drives (not included).
8. **AUDIO OUT jacks**
  - Use to connect a TV, an AV receiver / amplifier or other device with a composite audio cable.
9. **VIDEO OUT jack**
  - Use to connect a TV, an AV receiver or other device with a composite video cable.

## Using the Remote control

### Remote control

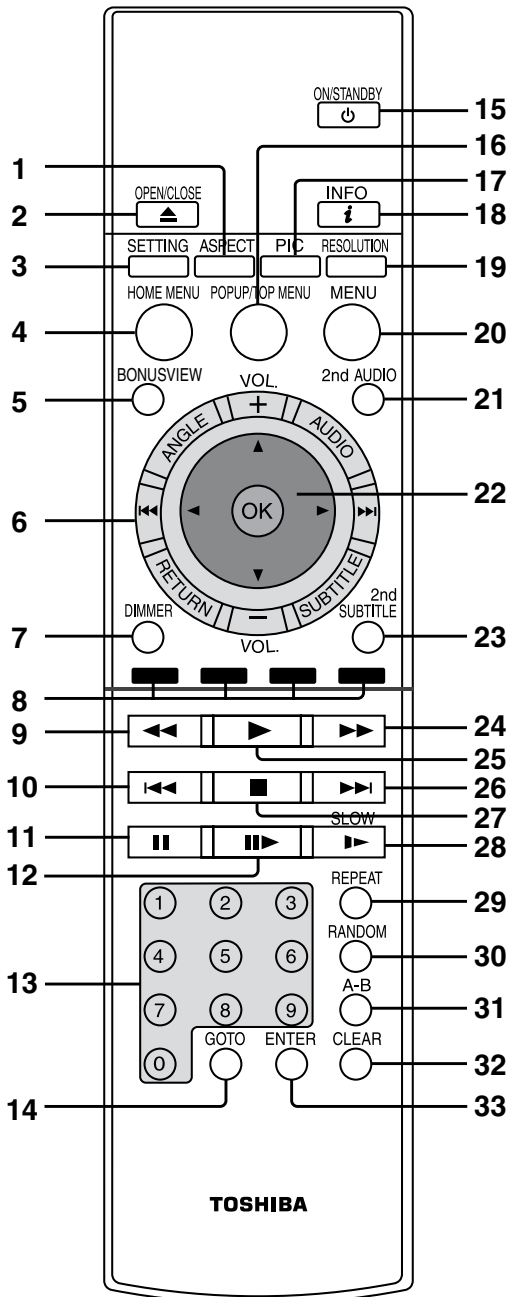

No.	Item	Description
1	<b>ASPECT</b>	Press to adjust aspect ratio in full stop mode.
2	<b>OPEN/CLOSE ▲</b>	Press to open or close the disc tray.
3	<b>SETTING</b>	Press to display the settings in home menu.
4	<b>HOME MENU</b>	Press to display the Connected in home menu.
5	<b>BONUSVIEW</b>	Press to switch picture-in-picture feature on or off (only applicable to BD-video which supports the PIP function). For more details, see "PIP (BONUSVIEW) Setting" on page 24.
	<b>◀◀ / ▶▶</b>	Same as <b>SKIP I◀◀ / SKIP ▶▶</b> . For detailed operations, please refer to <b>SKIP I◀◀ / SKIP ▶▶</b> .
6	<b>ANGLE</b>	Press to select a viewing angle if multiple angles are available on the disc.
	<b>VOLUME +/-</b>	Press to adjust the volume.
	<b>AUDIO</b>	Press to select the audio mode.
	<b>SUBTITLE</b>	Press to display the subtitle menu.
	<b>RETURN</b>	Press to return to the previous menu.
7	<b>DIMMER</b>	Press to adjust the brightness of display on the front of the Blu-ray disc player.
8	<b>RED / GREEN / BLUE / YELLOW</b>	<ul style="list-style-type: none"> <li>Press to select items on some BD contents.</li> <li>When file list / thumbnail list is shown, press to switch between pages.</li> </ul>
9	<b>REV ◀◀</b>	During playback, press to fast reverse the playback.
10	<b>SKIPI◀◀</b>	<ul style="list-style-type: none"> <li>During playback, press once to return to the beginning of the current title, chapter, track or file.</li> <li>During playback, press twice to return to the previous title, chapter, track or file.</li> <li>During the JPEG playback, press to return to the previous file.</li> </ul>
11	<b>PAUSE   </b>	<ul style="list-style-type: none"> <li>Press to pause playback.</li> <li>When playback is in pause mode, press repeatedly to forward the playback step by step.</li> </ul>
12	<b>  ▶</b>	Press to advance one frame.





13	<b>Number buttons</b>	<ul style="list-style-type: none"> <li>In playback mode, press <b>GOTO</b>, then press the number buttons to enter a title, chapter, track, time or file number.</li> <li>In menu mode, press to enter the parental code password.</li> </ul>
14	<b>GOTO</b>	Press to display the search menu.
15	<b>ON/STANDBY</b>	Press to turn on the unit, or to turn the unit into the standby mode. (To completely turn off the unit, you must unplug the power cord.)
16	<b>POPUP/TOP MENU</b>	<ul style="list-style-type: none"> <li>During Blu-ray Disc playback, press to open a menu that lets you control Blu-ray Disc playback.</li> <li>During DVD playback, press to open the DVD menu (if available).</li> </ul>
17	<b>PIC</b>	<p>In playback mode, press to adjust picture quality according to your preference (Actual effect to picture may vary depending on TV.):</p> <ul style="list-style-type: none"> <li>E.P.M (Enhanced Picture Mode): The picture is sharper with enhanced color.</li> <li>Sharpness</li> </ul>
18	<b>INFO</b>	Press to display disc information.
19	<b>RESOLUTION</b>	Press to select the video resolution in full stop mode.
20	<b>MENU</b>	Press to return to the previous menu.
21	<b>2nd AUDIO</b>	In PIP mode, press to turn the audio for the secondary video on or off. For more details, see "PIP (BONUSVIEW) Setting" on page 24.
22	▲ / ▼ / ◀ / ▶ <b>OK</b>	Press to select items or settings. Press to confirm or select menu items.
23	<b>2nd SUBTITLE</b>	In PIP mode, press to turn the subtitle for the secondary video on or off.
24	<b>FWD ▶▶</b>	During playback, press to fast forward the playback.
25	<b>PLAY ▶</b>	Press to start playback or resume playback.
26	<b>SKIP ▶▶▶</b>	<ul style="list-style-type: none"> <li>During playback, press to skip to the next title, chapter, track or file.</li> <li>During the JPEG playback, press to go to the next file.</li> </ul>
27	<b>STOP ■</b>	Press to stop playback.
28	<b>▶</b>	Press to play back the disc in slow motion.
29	<b>REPEAT</b>	Press to toggle between various repeat modes.
30	<b>RANDOM</b>	Press to turn random function on or off.
31	<b>A-B</b>	Press to play back a defined section between point A and B repeatedly.
32	<b>CLEAR</b>	Press to clear an input error.
33	<b>ENTER</b>	Press to confirm or select menu items.

## Installing batteries

Install the batteries (AAAx2) matching the polarity indicated inside battery compartment of the remote control.

### 1 Open the cover.

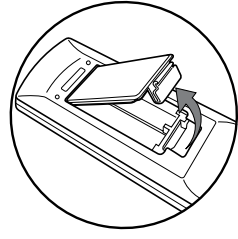

### 2 Insert batteries.

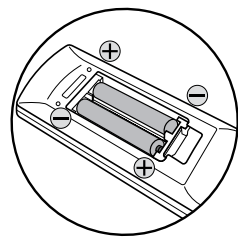

Make sure to match the + and - on the batteries to the marks indicated in the battery compartment.

### 3 Close the cover.

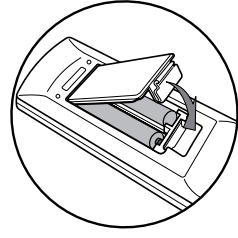

**Caution:** Never throw batteries into a fire.

#### Notes:

- Do not mix different battery types or combine used batteries with new ones.
- If the remote control does not operate correctly, or if the operating range becomes reduced, replace both batteries with new ones.
- If the batteries are dead or if you will not be using the remote control for a long time, remove the batteries to prevent battery acid from leaking into the battery compartment.

## Operating with the remote control

Point the remote control at the remote sensor and press the buttons.

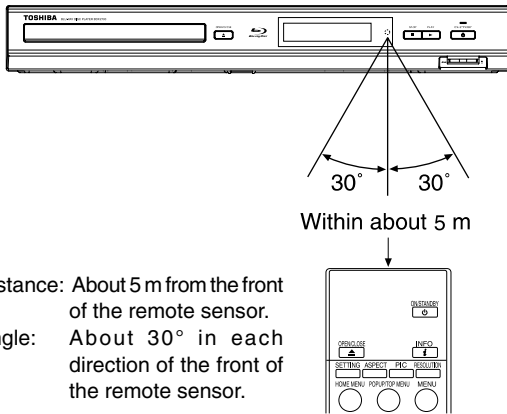

\* Do not expose the remote sensor of the Blu-ray disc player to a strong light source such as direct sunlight or other illumination. If you do so, you may not be able to operate the Blu-ray disc player via the remote control.

### Notes:

- Direct the remote control at the remote sensor of the Blu-ray disc player.
- When using the remote control, press the buttons at intervals of about 1 second to ensure the correct mode of operation.
- Do not drop or give the remote control a shock.
- Do not leave the remote control near an extremely hot or humid place.
- Do not spill water or put anything wet on the remote control.
- Do not open the remote control.
- If the remote control is not going to be used for a long time, remove the battery to avoid damage caused by battery leakage corrosion.

## Front Panel Display

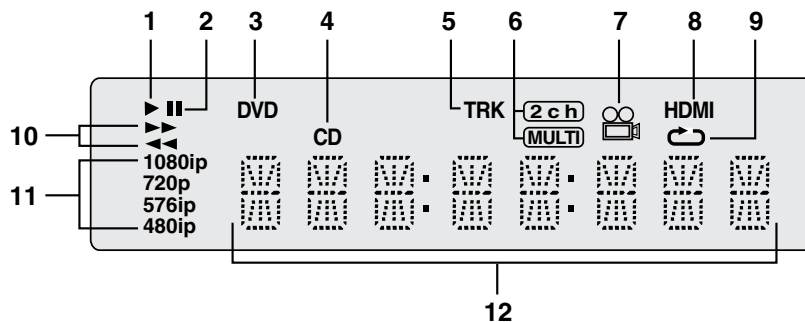

- 1. PLAY indicator**  
Lights when playing.
- 2. PAUSE indicator**  
Lights when paused.
- 3. DVD indicator**  
Lights when a DVD disc is inserted.
- 4. CD indicator**  
Lights when a CD disc is inserted.
- 5. TRK (TRACK) indicator**  
Lights when a CD/MP3 disc is inserted.
- 6. Audio Channel indicator**  
Shows the audio channel of the current DVD/BD.
- 7. Camera Angle indicator**  
Illuminates when a BD/DVD disc that has multiple camera angle is inserted.
- 8. HDMI indicator**  
Lights when HDMI TV is connected.
- 9. (REPEAT) indicator**  
Illuminates when REPEAT is pressed.

- 10. >>> / <<<< SKIP indicator**  
Lights while in fast forward / fast reverse mode.
- 11. Resolution indicator**  
Shows resolution of video output.
- 12. Character indicators**  
Displays various kinds of information such as elapsed time or message, etc. (See **Example** shown as below.)

00:03:24

Indicates the elapsed time

CLOSE

Closing the disc tray

BD

Indicates that a Blu-ray disc is inserted

LOADING

Loading a disc

# Connecting to a TV

Connect the Blu-ray player to your TV.

1. Choose the appropriate connection, then proceed to the corresponding instruction (A, B or C) on the next page.

## Best (Supports up to 1080i/1080p, 1080p/24F resolution.)

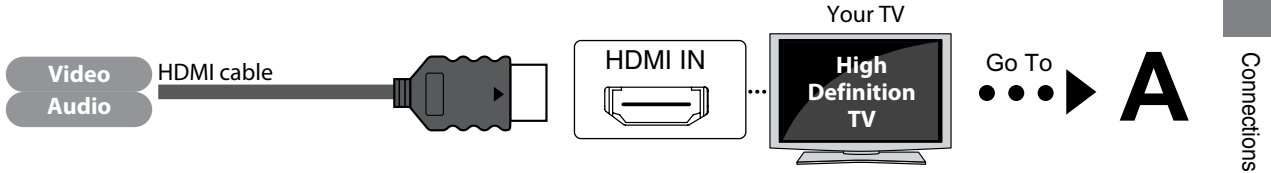

No analog audio connection required.

HDMI Cable NOT INCLUDED

## Better (Supports up to 1080i resolution.)

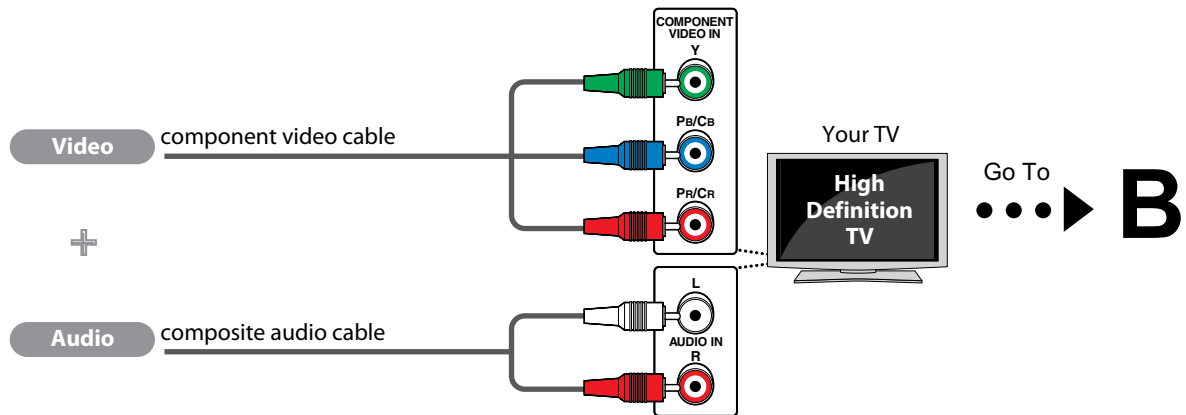

Component Video Cable NOT INCLUDED

## Basic (Supports only 480i resolution.)

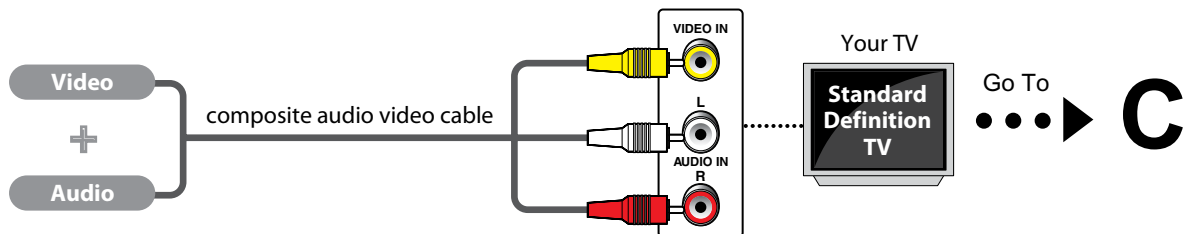

• Connect this unit directly to the TV. If the composite audio / video cables are connected to a VCR, pictures may be distorted due to the copy right protection system.

Composite Video / Audio Cables INCLUDED

2. Connect the cables by following the illustrations below.

Connecting a TV using an HDMI cable (Best)

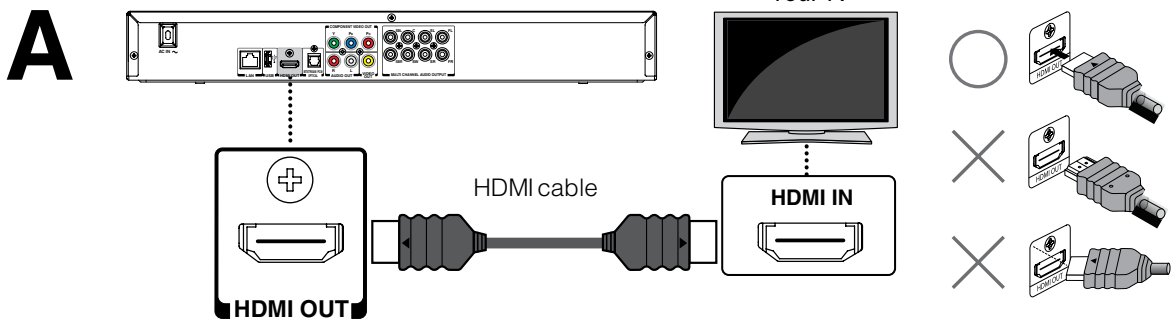

**Notes:**

- Do not tilt the connector when inserting it into the HDMI jack, and make sure the shapes of the jack and the connector are matched.
- When using non-HDCP compatible TV, the image will not display properly.
- An HDMI cable carries both video and audio signals. If you want to use TV speakers, you do not need to make an additional audio connection if you are using an HDMI cable.

Connecting a TV using a component video cable (Better)

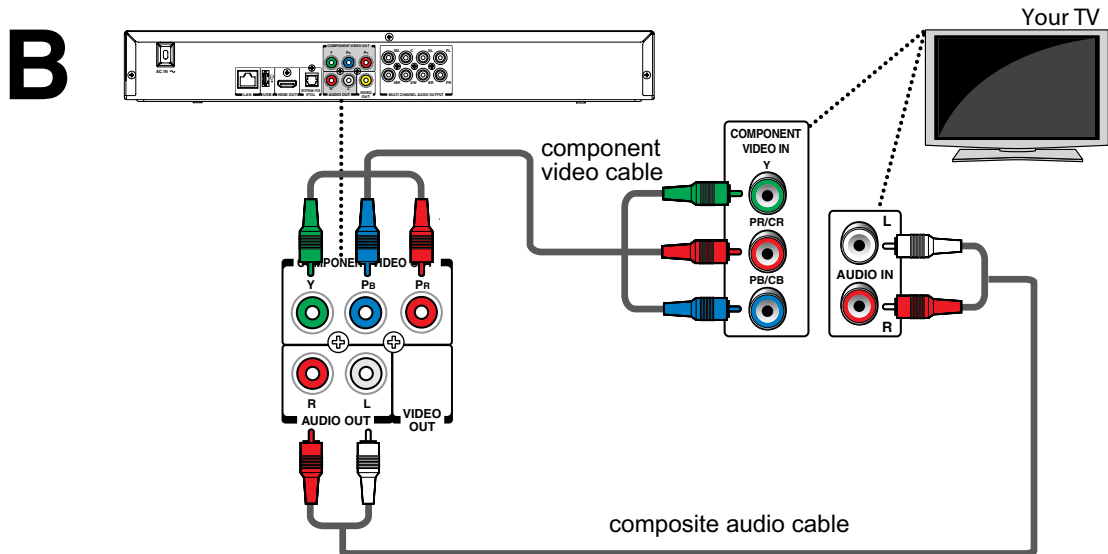

Connecting a TV using an A/V cable (Good)

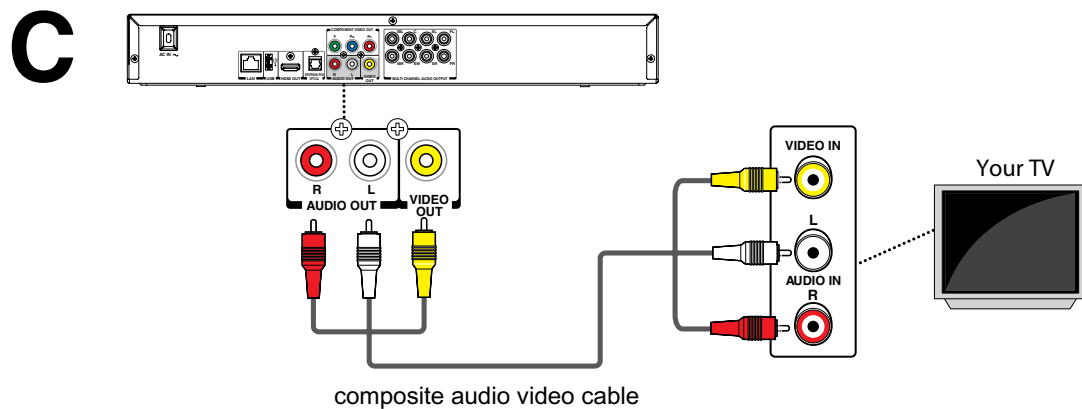

## Connecting to an Audio System

- When you change the connections, all devices should be turned off.
- Refer to the manual accompanying external devices for more information.

### Via 2-Channel Analog Audio Output

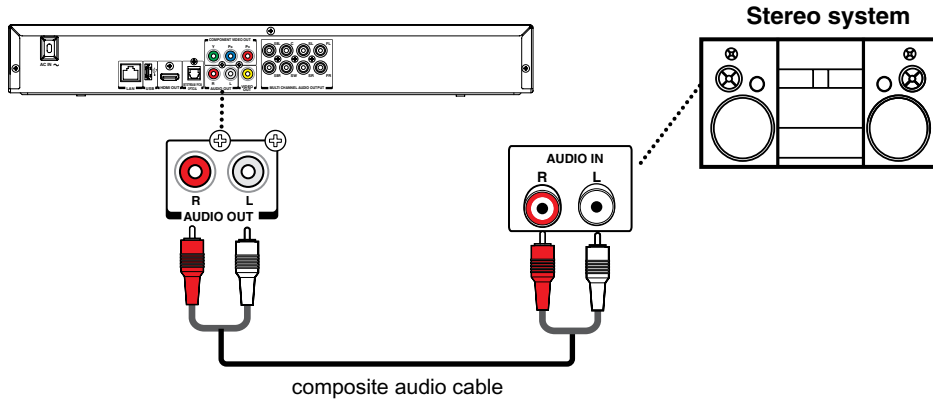

Connections

### Via Digital Audio Output

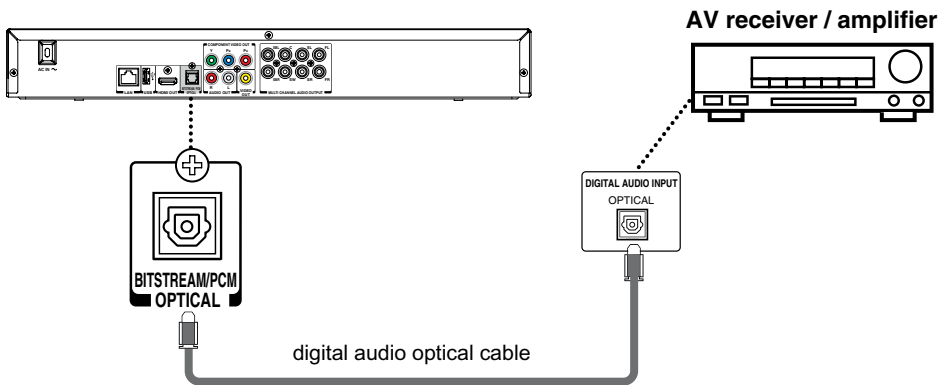

### Via HDMI Audio Output

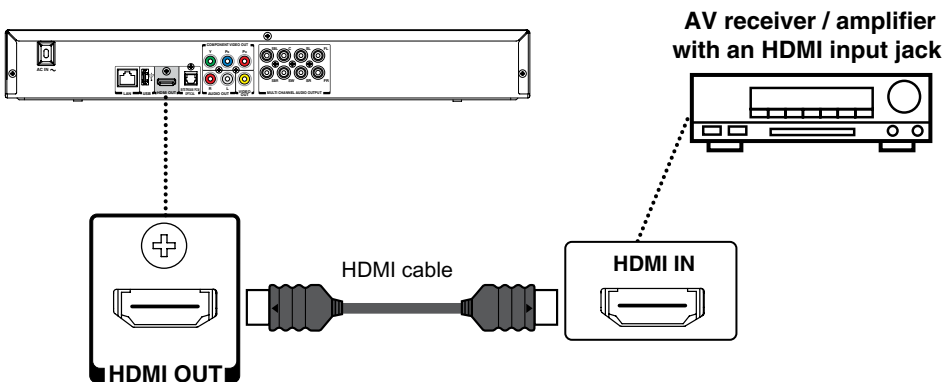

Digital Audio Optical Cable and HDMI Cable NOT INCLUDED.

## Wired Network Connection

Your Blu-ray disc player can be connected to your home network:

- By connecting an Ethernet cable to the **ETHERNET** jack on the rear of your player and to a wired hub or router. Using a wired network provides the best performance, because the attached devices connect directly to the network and are not subject to radio frequency interference.

### Connecting your player to a wired router:

- Connect an Ethernet cable (CAT5 or better with RJ45 connector) to the **ETHERNET** jack on the back of your player and to an Ethernet jack on a hub or broadband router.

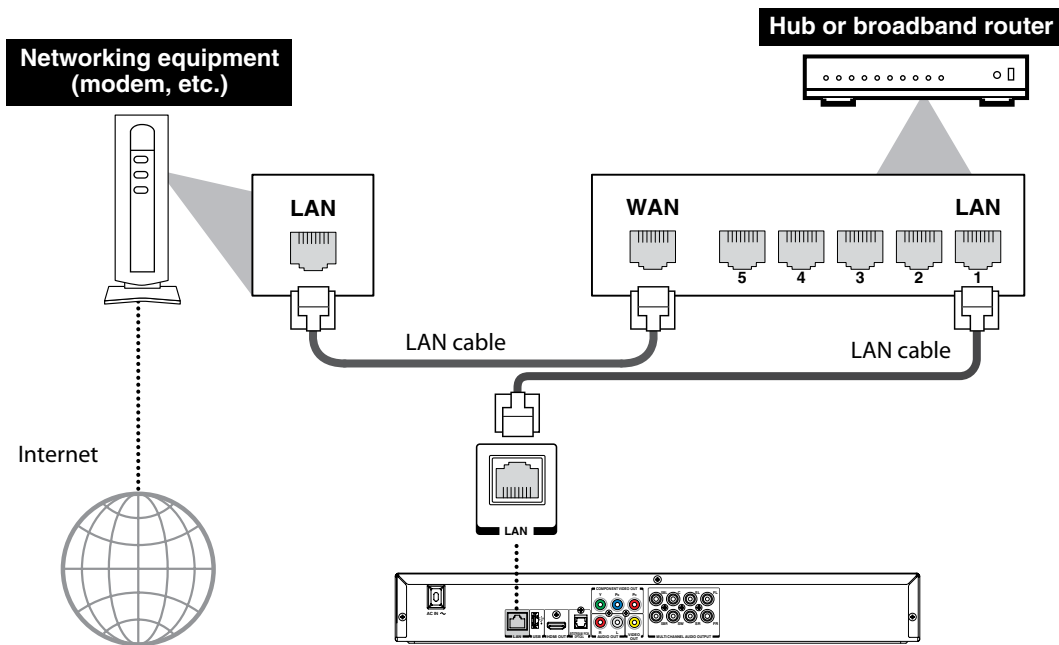

#### Notes:

- Do not connect a modular phone cable to the **ETHERNET** jack.
- When plugging or unplugging the cable, hold the connector on the end of the cable. When unplugging, do not pull on the cable. Press down the lock tab and pull the connector out of the jack.
- Because there are various connection configurations, follow the instructions from your telecommunication carrier or Internet service provider.

## Wireless Network Connection (Need the *OPTIONAL* Wi-Fi unit of sold separately)

Your Blu-ray disc player can also be connected to network with a Wireless access point.

1. A wireless AP/IP router is required to make a wireless network connection. Connect the wireless LAN adapter to the USB port on the rear panel of the Blu-ray Disc Player, and set the wireless network options (See Step 2 ~ 3).
2. After the Wi-Fi device inserts to USB terminal, press ▲ / ▼ to select "**Network**" from **Settings**, and press **OK** to enter.
3. Press ▲ / ▼ to select "**Wireless**", and press **OK** to enter.

(For detailed information, please refer to the user guide for WLM-10UB1.)

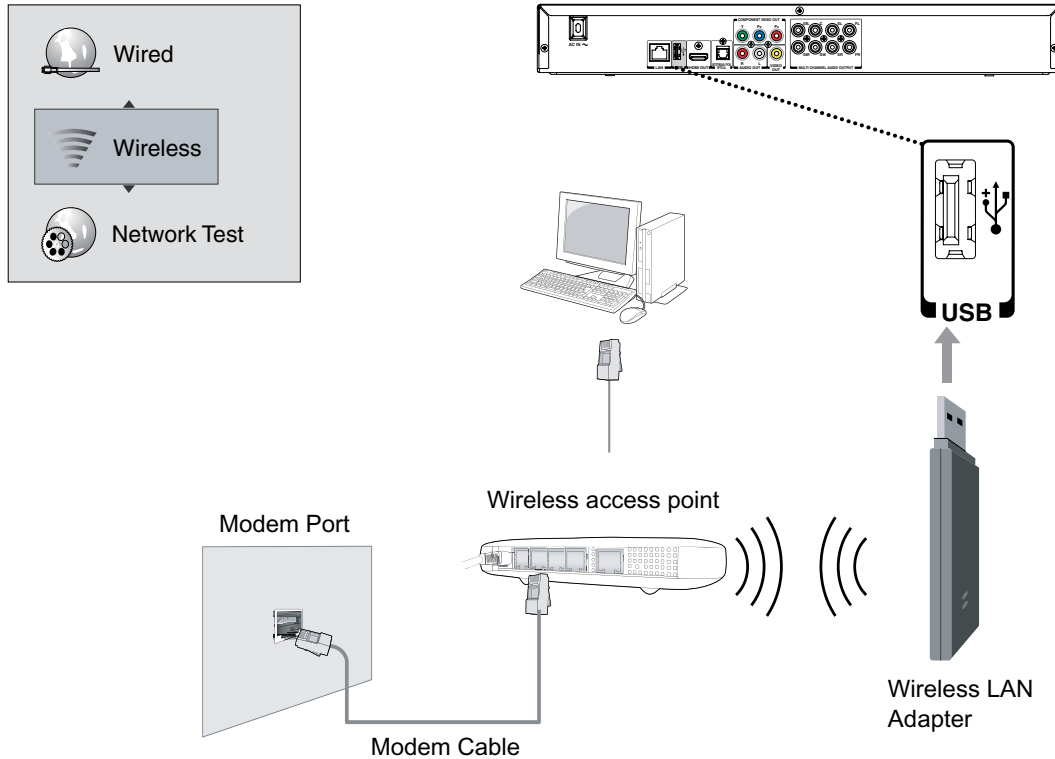

### Notes:

- This unit is compatible with TOSHIBA's Wireless LAN Adapter only.  
Model name: WLM-10UB1
- You must use a wireless IP sharer that supports IEEE 802.11 a/b/g/n. (n is recommended for stable operation of the wireless network.)
- Wireless LAN, in its nature, may cause interference, depending on the use condition (AP performance, distance, obstacle, interference by other radio devices, etc.).
- Set the wireless IP sharer to Infrastructure mode. Ad-hoc mode is not supported.
- When applying the security key for the AP (wireless IP sharer), only the following is supported.
  - 1) Authentication Mode : WEP, WPAPSK, WPA2PSK
  - 2) Encryption Type : WEP, TKIP, AES

## Connecting the Speakers (For 7.1 Audio Channel)

You can connect the speakers as shown in the following diagram to obtain the 7.1 audio channels effects. Using the audio cables, connect the **MULTI CHANNEL AUDIO OUTPUT** (SBL, SBR, C, SW, SL, SR, FL & FR) terminals on the rear of the Blu-ray disc player to 7.1 Channel ANALOG AUDIO IN terminals of your Amplifier.

For speaker configuration, please refer to “**Speaker Setting**” on page 32.

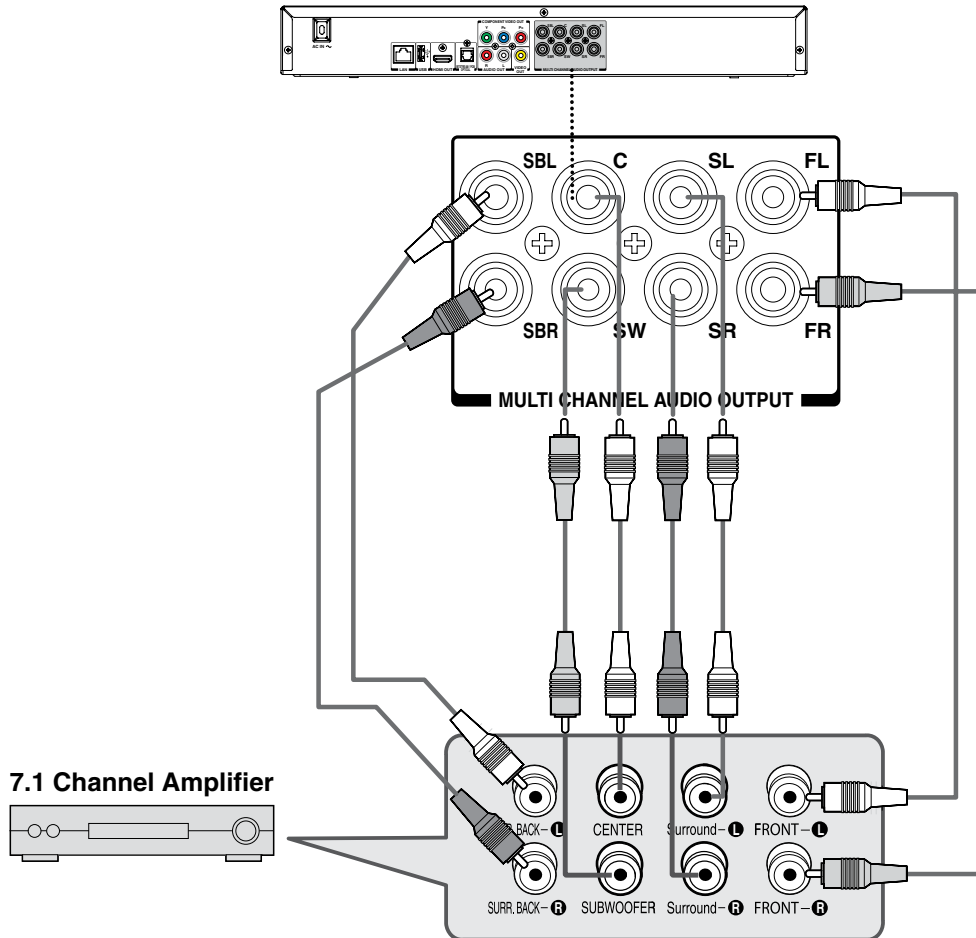

### Notes:

- Please turn the volume down when you turn on the Amplifier. Sudden loud sound may cause damage to the speakers and your ears.
- The position of terminals may vary depending on the Amplifier. Please refer to the user's manual of your Amplifier.
- The front left and right outputs on your player and 7.1 channel amplifier must be connected to hear disc menu audio from certain Blu-ray discs.
- When connecting to a 5.1 channel home theater or receiver, connect all the **MULTI CHANNEL AUDIO OUTPUT** jacks from the player except for the SBL (Surround Back Left) / SBR (Surround Back Right) outputs.



## Positioning the Speakers (For 7.1 Audio Channel)

How you set up your speakers can affect the bass and the sound field. Note the following points:

- Place speakers on flat secure bases.
- Placing speakers too close to floors, walls, and corners can result in excessive bass. Cover walls and windows with thick curtains.
- Keep your speakers at least 10 mm away from the system for proper ventilation.

### Setup example (For 7.1 audio channels)

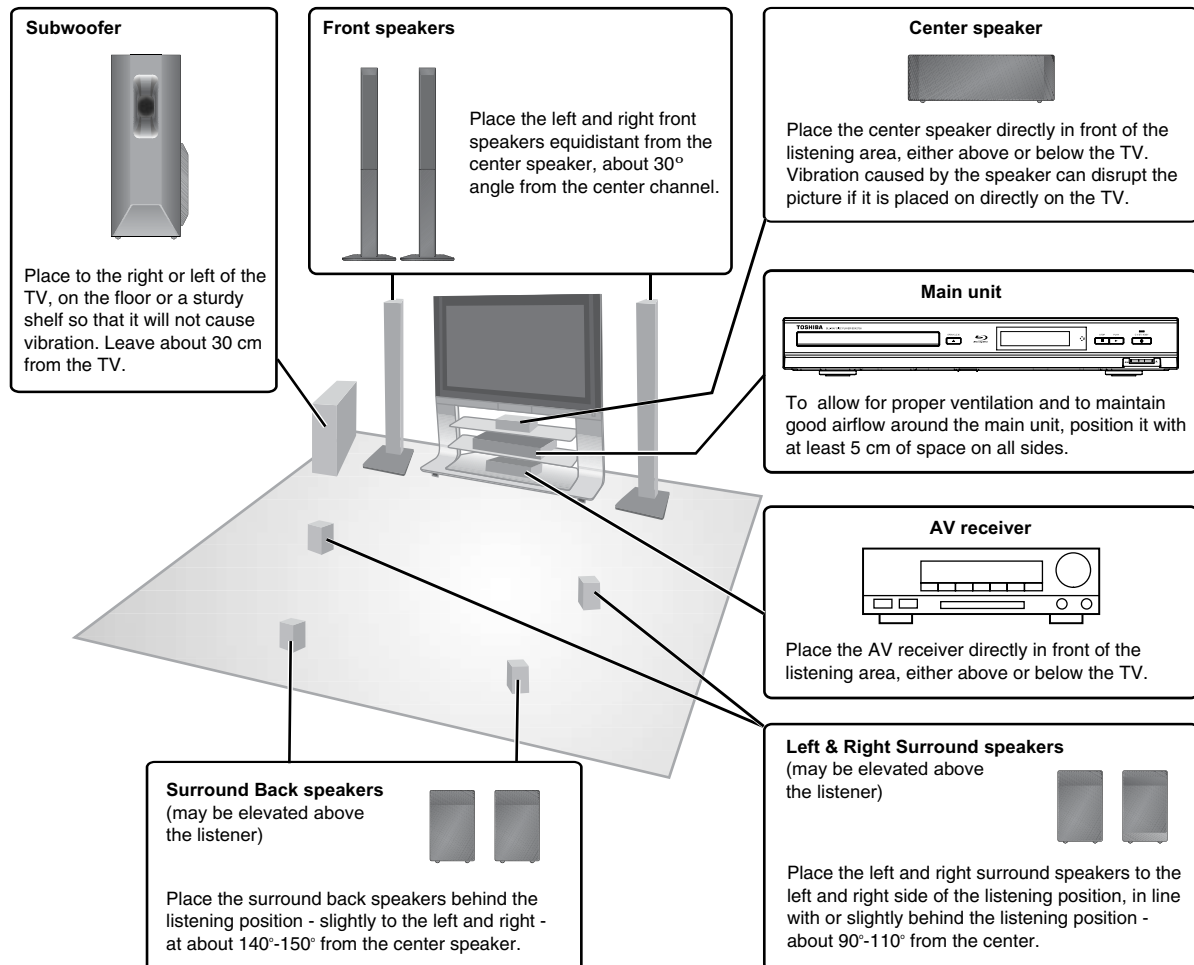

### Note:

The above setup illustration is a basic overview on what to expect when hooking speakers up to your home theater system. The placement may vary depending on how many and what type of loudspeakers you have, as well as your room size, shape, and acoustical properties.

# Information on Playback

Before you start playing back a disc, read the following information.

## Playable Discs and Files

This unit is compatible to play back the following discs / files.

To play back a disc / file, make sure that it meets the requirements for region codes and color systems as described below. You can play back discs that have the following logos.

Other disc types are not guaranteed to play back.

Playable discs	Logos
Blu-ray Disc - BD-ROM (single / dual layer) - BD-RE (single / dual layer) (Recorded in BDMV format) - BD-R (single / dual layer)(Recorded in BDMV format) (Unclosed discs may not be played back.)	
DVD-ROM	
DVD-RW	
DVD-R	
CD-DA (audio CD)	
CD-RW	
CD-R	
DTS-CD	-

Playable files	Media
AVCHD	DVD-RW/-R
MP3	BD-RE/-R, DVD-RW/-R, CD-RW/-R, SD Memory Card (including SDHC), miniSD Card, microSD Card
Windows Media™ Audio	
JPEG	

- This unit cannot playback the disc contents protected by Windows Media™ Digital Rights Management (DRM).

Readable cards	Playable files/data
SD Memory Card (8 MB - 2 GB)	MP3, Windows Media™
SDHC Memory Card (4 GB - 8 GB)	Audio, JPEG, picture-in-picture commentary, subtitles or other extras for BD-ROM
miniSD Card (8 MB - 2 GB)	
microSD Card (8 MB - 2 GB)	

- This unit supports SD Memory Card with FAT12/FAT16 file system, and SDHC Memory Card with FAT32 file system.
- This unit does not support NTFS file system.
- This unit may not read the SD Memory Cards formatted on a computer. If that is the case, please reformat the SD Memory Cards in this unit and try again.
- This unit does not support miniSDHC and microSDHC Memory Card.
- For miniSD Card and microSD Card, the adapter is necessary.

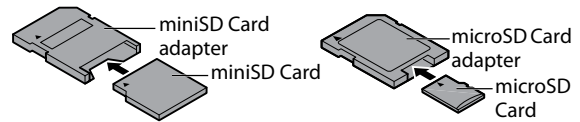

- Portions of this product are protected under copyright law and are provided under license by ARIS / SOLANA / 4C.
- Please keep the SD Memory Cards in their cases when you are not using them.
- Do not try to open or modify the card.
- Do not touch the terminal surface with your fingers or any metals.
- Do not attach additional labels or stickers to cards.
- Do not remove the label of the SD Memory Cards.
- This unit recognizes up to 8 characters of file name in the SD Memory Card. Characters after 8th will not be displayed.

## Unplayable Discs and Files

The following discs will not be played back in this unit.

- CD-ROM
- CD-I (compact disc-interactive)
- DVD-RAM
- VSD (video single disc)
- DVD-audio
- HD DVD
- VIDEO CD
- Unfinalized disc
- SACD
- BD / DVD / SD Memory Card contains DivX® files.
- BD / DVD hybrid disc (played back as a BD-video only)
- BD that contains AVCHD files
- DVD-RW/-R recorded in non compatible recording format.
- Super Audio CD - Only the sound on the CD layer can be heard. The sound on the high-density Super Audio CD layer cannot be heard.
- Playability of dual discs are not guaranteed.

## Color Systems

BD-video and DVD-video are recorded in different color systems throughout the world. The most common color system is NTSC (which is used primarily in the United States and Canada).

## Region Codes

This unit has been designed to play back BD-video with region "A" and DVD-video with region "1" or "ALL". You cannot play back BD-video or DVD-video that are labeled for other regions. Look for the symbols on the right on your BD-video or DVD-video.

If these region symbols do not appear on your BD-video or DVD-video, you cannot play back the disc in this unit. The letter or number inside the globe refers to region of the world. A BD-video or DVD-video labeled for a specific region can only be played back in the unit with the same region code.



BD-video



DVD-video

## Structure of Disc/SD Card Contents

The contents of BD / DVD / AVCHD are generally divided into titles. Titles may be further subdivided into chapters.

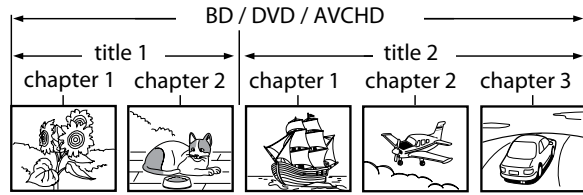

Audio CD is divided into tracks.



Data discs, USB device, SD Memory Cards containing MP3 / WMA / JPEG are divided into folders, and the folders are subdivided into files.

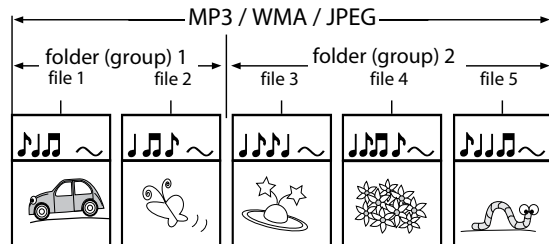

Playback

## Playing a Disc

This section shows you the basics on how to play a disc.

### CAUTION:

Keep your fingers well clear of the disc tray as it is closing. Neglecting to do so may cause serious personal injury.

### Basic playback



AVCHD



CD

#### Preparations

- When you want to view a disc, turn on the TV and select the video input connected to the Blu-ray disc player.

#### 1 Press the ON/STANDBY button.



The Blu-ray disc player turns on.

#### 2 Press OPEN/CLOSE.



The disc tray opens.

#### 3 Place the disc on the disc tray.

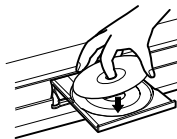

With the playback side down

#### 4 Press OPEN/CLOSE to close the disc tray.



Playback starts.

If you insert a Blu-ray disc or a DVD that contains a top menu, a menu may appear. Use ▼/▲/◀/▶ to select the title you want to view, then press **OK** to start playback.

- You may need to press the **POPUP/TOP MENU** or **MENU** button to display disc menu (depending on the actual Blu-ray disc or DVD.)

#### ■ To start playback in the stop mode

Press ► **PLAY**.

#### ■ To pause playback (still mode)

Press || **PAUSE** during playback.

To resume normal playback, press the **PLAY** button.

- The sound is muted during still mode.

#### ■ To stop playback

Press ■ **STOP**. The setup menu is displayed.

To resume normal playback, press ▼/▲ to select DVD/BD-ROM, then press **OK**.

- Depending on the disc, playback starts where it stopped or at the beginning of the disc.

If you press ■ **STOP** twice, playback stops completely.

To start playback again, press ► **PLAY**. Playback starts at the beginning of the disc.

#### ■ To remove the disc

Press **OPEN/CLOSE**.



Remove the disc after the disc tray opens completely.

Be sure to press the **OPEN/CLOSE** button to close the disc tray after you remove the disc.

#### ■ To turn the power off

Press **ON/STANDBY** button to turn the unit off.

## Variable Speed Playback

You can play discs at various speeds, and resume playback from the location where you stopped playback.

### Playing in fast reverse / forward directions



Press ◀◀ or ▶▶ during playback.

▶▶ : Fast forward playback

◀◀ : Fast reverse playback

Each time you press this button, the fast-forward or fast-reverse speed changes in the following sequence:

Fast x 2 → Fast x 4 → Fast x 8 → Fast x 16  
→ Fast x 32 → Fast x 64 → Fast x 128.

■ To resume normal playback

Press ▶ PLAY.

Notes:

- The Blu-ray disc player mutes sound and subtitles during reverse and forward scan of DVDs.
- The playback speed may differ depending on the disc.

### Playing frame by frame



Press ⏮▶ during still playback.



Each time you press this button, the picture advances one frame.

■ To resume normal playback

Press ▶ PLAY.

Note:

- The sound is muted during frame by frame playback.

### Playing in slow-motion



Press ⏪▶ during playback.



Each time you press this button, the slow-motion speed changes in the following sequence:

Slow x 1/2 → Slow x 1/4 → Slow x 1/8

■ To resume normal playback

Press ▶ PLAY.

Notes:

- The sound is muted during slow-motion playback.
- 3 speeds are available.

## Locating a Desired Section

Normally, Blu-ray discs and DVDs are divided into titles, and the titles are sub-divided into chapters. Audio CDs are divided into tracks. You can quickly locate any specific title, chapter, or track.

### Locating a title using the top menu



**1** Press POPUP/TOP MENU.

POPUP/TOP MENU



The top menu appears on the TV screen.

e.g.

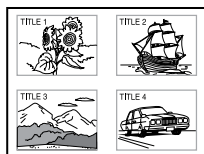

**2** Press ▼ / ▲ / ◀ / ▶ to select the title you want.

If the titles in the top menu are assigned a number, you can directly locate a specific title by pressing its designated number with the number buttons.

**3** Press OK.

Playback starts from Chapter 1 of the selected title.

## Locating a specific chapter or track



Press **⏮** or **⏭** repeatedly to access the chapter or track number you want.

Playback starts from the selected chapter or track.

**⏭** To locate succeeding chapters or tracks.

**⏮** Playback starts from the beginning of the current chapter or track. When you press twice in quick successions, playback starts from the beginning of the preceding chapter or track.

**⏭** and **⏮** refer to item 26 and item 10 on page 9 and page 8 respectively.

You can also press **⏮** or **⏭** (shown as in the right illustration) on the remote control to access the desired chapter or track.

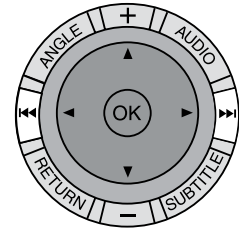

**Note:** Some titles may not display chapter numbers.

## Accessing a Specific Location Directly

### Locating a specific title/chapter/time



#### 1 Press GOTO.

The Goto menu appears on the TV screen.

GOTO  
○ e.g.



a. Press the GOTO button once:

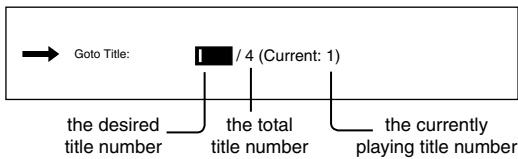

b. Press the GOTO button twice:

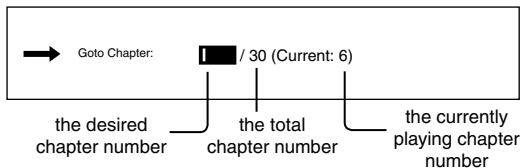

c. Press the GOTO button for 3 times:

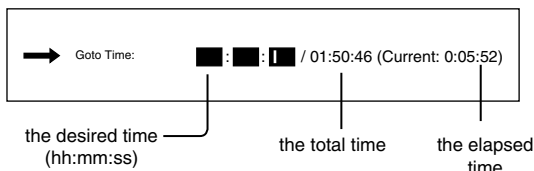

**CD** (Press GOTO once)

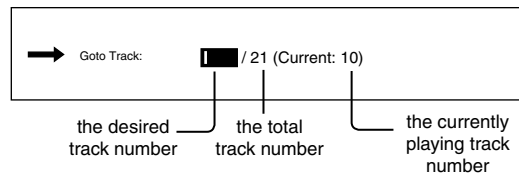

**CD MP3 WMA** (Press GOTO twice)

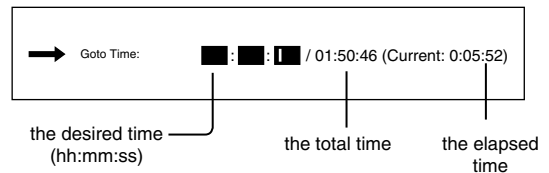

#### 2 Press the number buttons to enter title, chapter (track) number or time.

**MP3 WMA JPEG** (Press GOTO once)

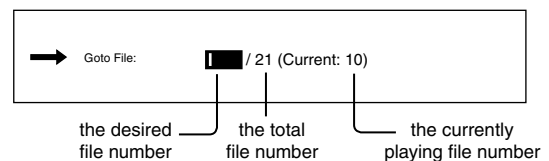

While accessing the TIME using number buttons, just enter 2 digits in order.

The first two numbers you entered represent hours. The second two numbers you entered represent minutes.

The third two numbers you entered represent seconds. Press the **CLEAR** button to reset the numbers.

#### 3 Press OK.

Playback starts from the selected section.

## Repeating a Title, Chapter, Track or Specific Segment

### Repeating a title, chapter or track



Press REPEAT repeatedly to select the desired repeat mode during playback.

e.g.

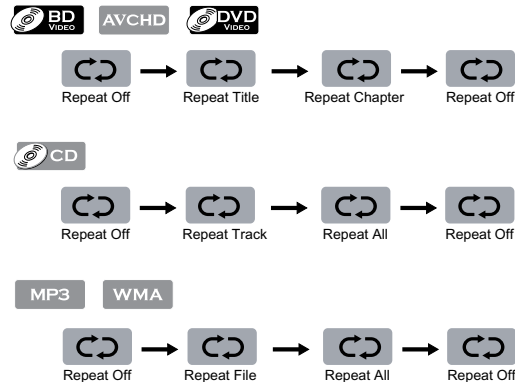

#### Notes:

- The repeat setting will be cancelled when you stop playback.
- The chapter, title or track repeat will be cleared when moving to another chapter, title, track / file or folder.
- Repeat playback does not function during A-B repeat playback.
- Chapter and title repeat are not available with some scenes.
- When the repeat setting is set for a MP3 or WMA folder (file), the repeat setting will be canceled if you select other MP3 or WMA folder (file) to playback.

Playback

### Repeating a specific segment



**1** Press A-B at the desired starting point A during playback.



Repeat A-

**2** Press A-B at the desired ending point B during playback.



Repeat A-B

The DVD player automatically returns to point A and starts repeat playback of the selected segment (A-B).

#### ■ To resume normal playback

Press A-B until is displayed.

#### Notes:

- Some discs may not permit A-B repeat operation.
- You can specify a segment only within the current title or track.
- You cannot set the A-B repeat function for a segment that includes multiple camera angles.
- A-B repeat does not function during chapter, title, track or all repeat playback.

## Playing in a Random Order

### Playing tracks or files in a random order



Press RANDOM repeatedly to select Random ON during playback.

Once you turn RANDOM function on, the RANDOM indicator will be activated and the system will play all files in a random sequence.

#### ■ To resume normal playback

Press RANDOM repeatedly until " Random Off" is displayed.

## PIP (BONUSVIEW) Setting

Some Blu-ray discs have the PIP function which enables you to display the secondary video in the primary video. You can call up the secondary video by pressing **BONUSVIEW** whenever the scene contains the secondary video. See the documentation that came with the disc for playback instructions.

**1** Press **BONUSVIEW** during playback to turn PIP mode on.



**2** Press 2nd **AUDIO** to turn the audio for the video in the PinP window on or off.



**3** Press 2nd **SUBTITLE** to turn the subtitle for the video in the PinP window on or off.

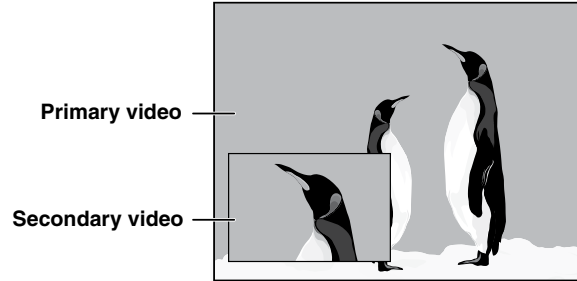

### ■ To resume normal playback

Press **BONUS VIEW** to turn off the PIP mode.

#### Note:

- PIP audio cannot be heard unless **Bitstream Mixed** has been selected on the Audio menu. For more information, see "Audio Setting" on page 31.

## Camera Angle

Some BD-video and DVD-video contain scenes which have been shot simultaneously from various angles.

**1** During playback, press **ANGLE**.

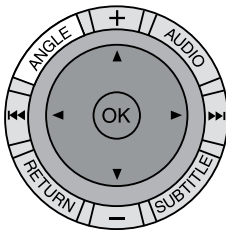

The selected angle will be displayed on the display bar at the top of the TV screen.



The first digit indicates the current viewing angle, and the second digit indicates the total number of viewing angles.

**2** Press **▶**, then use **▼ / ▲** to select the desired angle.

## Audio Selection

**1** During playback, press **AUDIO**.

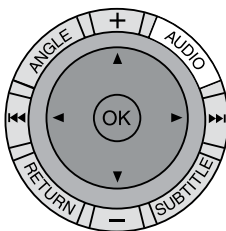

In the example "01/03 ENG Dolby TrueHD", "01" indicates the currently selected audio channel. "03" indicates the total number of audio channels. "ENG" indicates the audio language. "Dolby TrueHD" describes the currently selected audio format.

**2** Press **▶**, then use **▼ / ▲** to select the desired audio language and audio format.



#### Notes:

- The available options of Audio vary from different disc format.
- PIP Subtitle is not available for all discs. It only applies to Blu-ray discs that supports picture-in-picture features.



## Subtitle Selection



**1** During playback, press **SUBTITLE**.

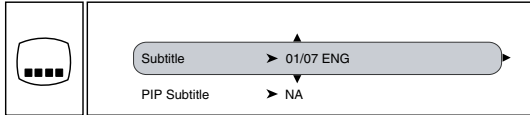
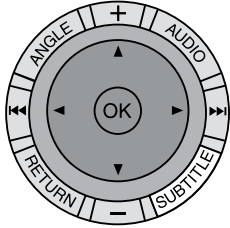

In the example “01/07 ENG”,  
 “01” indicates the currently selected subtitle.  
 “07” indicates the total number of subtitles.  
 “ENG” indicates the subtitle language.

**2** Press **▶**, then use **▼ / ▲** to select the desired subtitle.

**Notes:**

- The available options of Subtitle vary from different disc format.
- PIP Subtitle is not available for all discs. It only applies to Blu-ray discs that supports picture-in-picture features.

Playback

## Displaying On-screen Information

You can check information about the current disc by pressing **i**.

### On-Screen display



Disc format	On-Screen Display
	Title 1 Chapter 1/25 0:02:00  1:57:35 Off
	Title 1 Chapter 1/18 0:02:00  1:57:35 Off
	Track 1/12 0:00:20  0:05:35 Off
	File: 1/5 song1.mp3 Title: Cool Track Artist: Ricardo Funiccio Album: Dead Dux 0:02:00  0:30:00 Off
	File: 4/13 flower.jpg Off

# Playing AVCHD/MP3/WMA/JPEG Files

AVCHD MP3 WMA JPEG

You can play AVCHD, MP3, WMA or JPEG files that have been recorded on a disc on the Blu-ray disc player.

## Playing files on a data disc

When you insert a data disc containing picture, music, or video files into your player, icons are added to the menu to indicate that video, music, or picture files are available for playback.

### 1 Press OPEN/CLOSE to open the disc tray, place a disc that contains video/MP3/JPEG Files.

A selection menu will appear on the screen.

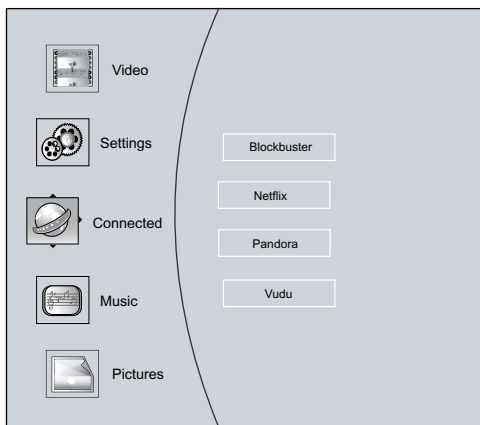

### 2 Press ▼ / ▲ to select the Music or Pictures, and then press OK. (For example: selecting the Music)

If no USB device or SD card is inserted, the system will directly access the following screen:

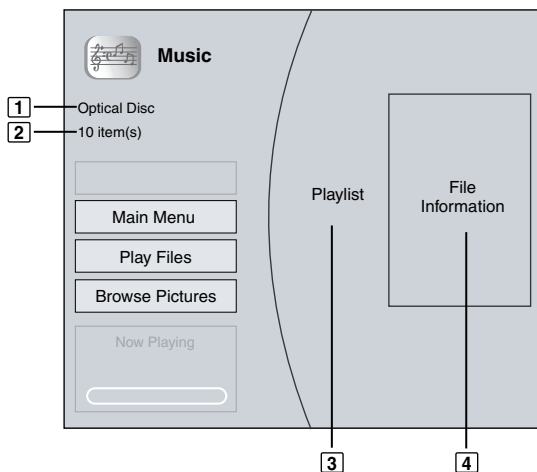

- 1: displays source (Optical Disc/USB/SD) device name.
- 2: defines the total number of files that a device contains.
- 3: shows all files name.
- 4: shows the information on the currently selected file.

If a USB device and a SD card containing music are inserted at the same time, the system will enter the source selection screen shown as below:

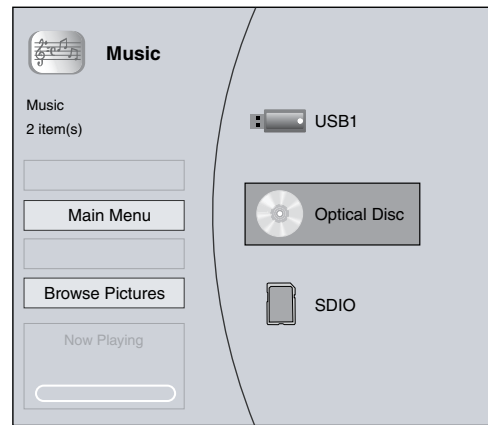

For SD card and USB device operation, please refer to "Using an SD card" on page 27 and "Using a USB Device" on page 28.

### 3 Press ▼ / ▲ to select the desired MP3 file, and then press OK to start playing.



- ⌘ : Press **RANDOM** repeatedly to turn random playback on or off.
- ↺ : Press **REPEAT** repeatedly to select the desired repeat mode.

### 4 To view JPEG picture files while playing music files, follow the following steps:

1. Press **RETURN**.
2. Use ▼ / ▲ to select Browse Pictures, then press **OK**.
3. Select the desired JPEG file and press **OK** to start viewing.



**1** — Optical Disc  
**2** — 30 item(s)  
**3** — Now Playing File: 13/30  
**4** — Thumbnail

**1**: displays source (Optical Disc/USB/SD) device name.  
**2**: defines the total number of files that a device contains.  
**3**: shows the currently playing file number.  
**4**: shows all pictures in thumbnail mode.

**Settings:** This option enables you to define Slide Show Effects (None, Horizontal Scroll, Fade and Shutter) and Slide Show Delay (5 Seconds, 2 Seconds, 1 Seconds, No Delay, 10 Seconds, 15 Seconds and 30 Seconds). After setting, press ▼ to highlight Ok and then press **OK** to confirm.

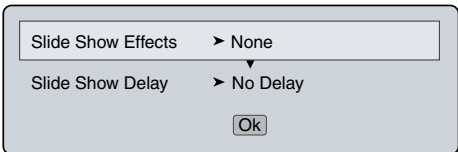

- Main Menu:** Returns to the main menu.
- Media Menu:** Returns to select the source. This item only appears if your optical disc, USB device or SD card is inserted.
- Previous Folder:** This item only appears if your optical disc, USB device or SD card contains several different picture folders.
- Start Slide Show:** This option enables you to view picture (files) one after another automatically.
- Browse Music:** Goes back to Music folder.

## 5 To stop playing and return to the main menu, follow one of the steps described below:

- Press **STOP**.
- Press **RETURN**.
- Press ◀, then use ▼ / ▲ to highlight Main Menu and then press **OK** to confirm.

Playback

## Using an SD Card

This unit supports the use of a Secure Digital (SD) card (not included).

**CAUTION:** Before inserting the SD card, please read carefully the relevant information on “**Playable Discs and Files**” on page 18.

### Inserting an SD card

**1** Inserting an SD card fully into the slot on the front of Blu-ray disc player until it clicks as illustrated.

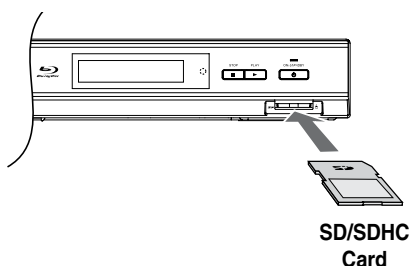

**2** Press ▼ / ▲ to select Music or Pictures, and then press **OK**.

If no USB device or optical disc containing music or pictures is inserted, the system will directly load the data on the inserted SD card. Otherwise, it will enter the source selection screen. If so, please follow the operation instructions in “**Playing files on a data disc**” on page 26 for details.

- **To pause playback**  
Press **II** during playback. To resume normal playback, press **▶ PLAY**.
- **To stop playback**  
Press **■ STOP**.
- **Removing the SD card**  
In stop mode, gently push the SD card into the slot and then pull it out slowly.

- Notes:**
- If you cannot easily insert the memory card, you may have inserted it incorrectly. Try to turnover the card and then insert again. Do not force the memory card into the memory card slot.
  - Do not remove the SD card during playback.

## Using a USB Device

You can play video, MP3 or JPEG files that have been stored on USB devices on the Blu-ray disc player.

### Operating a USB device

**1** Inserting a USB device into the USB slot on the back of Blu-ray disc player until it clicks.

**2** Press **▼ / ▲** to select **Video, Music or Pictures**, and then press **OK**.

If no optical disc or SD card containing music or pictures is inserted, the system will directly load the data on the USB device. Otherwise, it will enter the source selection screen. If so, please follow the operation instructions in "**Playing files on a data disc**" on page 26 for details.

■ **To pause playback**

Press **⏸** during playback. To resume normal playback, press **▶ PLAY**.

■ **To stop playback**

Press **■ STOP**.

■ **Removing the USB device**

In stop mode, gently pull the USB device out slowly.

**Notes:**

- If you cannot easily insert the USB device, you may have inserted it incorrectly. Try to turnover the device and then insert again.
- Do not remove the USB device during playback.

# Customizing the Function Settings

You can change the default settings to customize performance to your preference.

## General Operations

1. Press ▼ / ▲ to select **Settings** in home menu while in full stop mode, the Settings menu appears.
2. Press ► button, then use ▲ / ▼ button to select the setting options.
3. Press **OK** button.
4. Press ◀ or **RETURN** button to return to the previous menu.

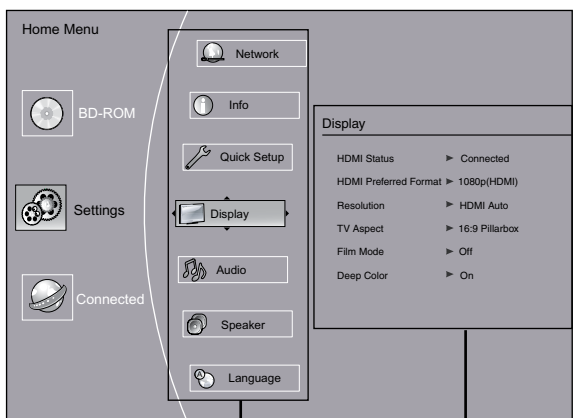

Settings menu items    submenu display area

## Network Connection Setting

1. Press ▼ / ▲ to select **Network** in stop mode, the network connection menu appears.

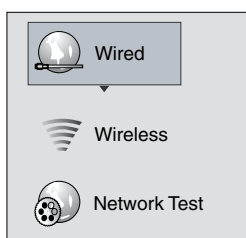

2. Press ► button, then use ▲ / ▼ button to select the desired connection setting.
3. Press **OK** button.

**Note:** The option **Wireless** appears only while a wireless LAN adapter is inserted into the USB slot.

### Configuring a wired Internet connection

1. Press ▼ / ▲ to select **Wired**, then press **OK** to confirm. The IP Settings screen appears.

If the network connection is active, **Link Up** appears next to Link Status. If the network connection is not active, **Link Down** displays next to Link Status.

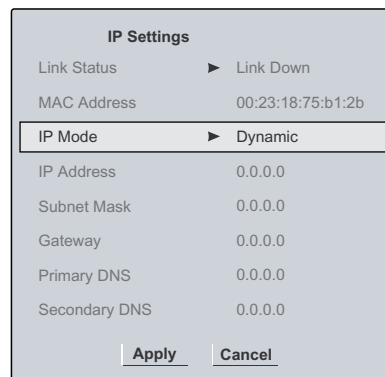

2. Press ▼ / ▲ to select **IP Mode**, then press **OK**.
3. Press ▼ / ▲ to select an IP mode. You can select:
  - **Off** — Disables the network interface.
  - **Manual** — Lets you manually configure network settings, such as IP address, subnet mask, and gateway settings.
  - **Dynamic** — Uses DHCP to automatically obtain an IP address.
4. Press ◀ or **RETURN** to go to the previous menu.

## Info Menu

This menu displays the following information:

- **Software Version**
  - **Software Date**
  - **Netflix ESN**
1. In the main menu of **Settings**, press ► button, then use ▲ / ▼ button to select **Info** to display the version information on software and hardware.
  2. Press ◀ or **RETURN** to go to the previous menu.

## Performing Quick-Setup

1. In the main menu of **Settings**, press ► button, then use ▲ / ▼ button to select **Quick Setup**, and then press **OK** to confirm.
2. Press **OK** to perform Quick Setup.  
To exit the setup menu:
  - Use ▼ button to highlight "No thanks. I'll go through the full setup menu later", and then press **OK**.
  - Or press ◀ button directly.
3. Follow the on-screen instructions to customize the following settings to your preference:
  - **OSD Language Settings**
  - **Resolution**
  - **TV Aspect**
4. After setting, press **OK** to confirm and exit the setup.

## Customizing the Function Settings

### Display Setting

1. In the main menu of **Settings**, press ► button to select **Display**, and then press **OK** to confirm.

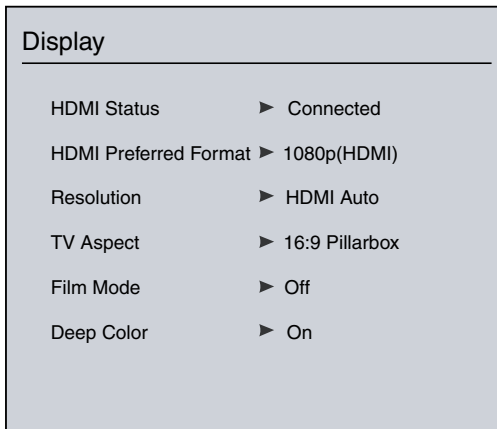

2. Press ▲ / ▼ to select an option, and then press **OK**.
3. Use ▲ / ▼ to select the desired option, and then press **OK** to confirm your selection.
4. Press ◀ to go to the previous menu.

#### HDMI Status:

This option displays the HDMI status. If an HDMI TV is connected, **Connected** appears. If an HDMI TV is not connected, **Disconnected** appears.

#### HDMI Preferred Format:

This option shows the best HDMI format for the connected TV.

#### Resolution:

You can define the video output resolution in this option. In case that the menu of "Resolution" setting disappears, make composite video (yellow) connection to restore it, then select the resolution which is compatible with the connected TV.

#### Notes:

- Selecting a resolution the TV does not support could result in an unstable picture or loss of the picture. See the documentation that came with the TV to find the resolutions the TV supports.
- Only the HDMI output on your player supports 1080p video output at any frame rate. If the TV is connected to the component output, the video output is limited to 1080i or lower.

TV Type	Resolution
If your TV is a high-definition TV(HDTV) connected to the HDMI jack on your player and you want your player to set the output resolution based on information exchanged between the TV and your player over the HDMI cable.	HDMI Auto
If the TV is a high-definition TV (HDTV) capable of 1080p (any frame rate) connected to the HDMI jack on your player	1080p (HDMI)
If your TV is a high-definition TV (HDTV) capable of 1080i only	1080i
If your TV is a high-definition TV (HDTV) capable of 720p only	720p
If your TV is an enhanced-definition TV (EDTV)	480p
If your TV is a standard-definition NTSC TV (American or Asian SD TV)	480i

#### TV Aspect:

**16:9 wide, 16:9 Pillarbox, 4:3 Pan and Scan** and **4:3 Letter Box** are available for your choice.

#### Film Mode:

Movies are recorded on film at a rate of 24 pictures (frames) per second. Many of the movies on Blu-ray discs are placed on the discs at this frame rate. If your TV supports 24 frames per second, but you would prefer viewing the video at a higher frame rate, you should turn off Film Mode. **Off** selects a 60 frames/second output format.

#### Deep Color:

This option decides whether to turn off the Deep Color (color depth) setting for video signals output from the HDMI OUT jack.

Connecting the player and a TV that supports Deep Color allows more accurate color reproduction than when connecting it to a TV that does not support Deep Color. It is recommended to set this option **Off** if the picture is unstable or colors appear unnatural.

# Customizing the Function Settings

## Audio Setting

The settings in the Audio menu will configure the BD player's digital audio outputs (**HDMI** or **Optical**).

1. In the main menu of **Settings**, press ► button, then use ▲ / ▼ button to select **Audio**, then press **OK** button.

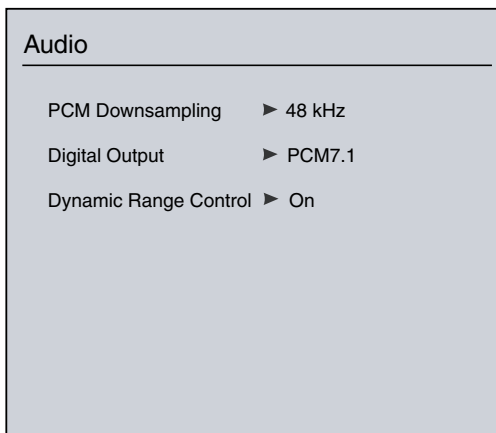

2. Press ▲ / ▼ to select an option, and then press **OK**.
3. Use ▲ / ▼ to select your preferred audio items, and then press **OK** to confirm your selection.
4. Press ◀ to go to the previous menu.

### PCM Downsampling:

**If you don't have a surround sound receiver connected to the BD player**, you should **leave the PCM downsampling to 48 KHz**, and proceed to the next setup menu item. This is true regardless of whether the audio is connected to the TV with HDMI or the analog stereo outputs.

**If you have a surround sound receiver connected to the BD player, and you have connected to the surround receiver via the BD player's analog multichannel audio outputs**, this setting has no effect on the audio going to the analog outputs of the player. Leave the PCM downsampling to 48 KHz, and proceed to the next setup menu item.

**If you have a surround sound receiver connected to the BD player, and you have connected to the surround receiver via the BD player's HDMI output**, this setting has no effect on the audio going to the HDMI output of the player. **Leave the PCM downsampling to 48 KHz**, and proceed to the next setup menu item.

**If you have a surround sound receiver connected to the BD player via optical cable**, set this menu item to the maximum PCM sampling rate that your surround receiver can accept (48 KHz or 96 KHz). **If in doubt, consult your surround receiver's manual or set to 48 KHz.**

**NOTE:** Incorrectly setting the digital audio output's PCM sampling rate too high may result in unpredictable audio playback.

### Digital Output:

- **PCM Stereo** — Sets the output to PCM Stereo if you have not an audio receiver connected to your Blu-ray disc player or the audio receiver connected to Blu-ray disc player is not a 5.1/7.1 channel receiver.
- **Bitstream HD** — Lets your player send Dolby TrueHD or DTS-HD MA bitstreams over HDMI (if your player is connected to a compatible HDMI audio receiver). If your player is not connected to a compatible HDMI receiver (for example, your player is connected directly to the TV or your player is connected to an audio receiver using an optical cable), a compatible audio signal is automatically sent over the HDMI and optical connections. With this setting, Blu-ray audio is limited to the soundtrack for the main movie (no PIP audio).
- **Bitstream Legacy** — Sends a DTS or Dolby Digital bitstream from the disc over the HDMI and optical connections. Blu-ray audio is limited to the soundtrack for the main movie (no PIP audio).
- **Bitstream Mixed** — Sends a mixed (PIP audio and movie audio) DTS audio stream over the HDMI and optical connections. This mode is primarily intended for use when you want to hear both PIP audio and the movie audio.
- **PCM 5.1** — Sends a PCM audio signal of up to 5.1 channels over the HDMI connection and up to 2 channels over the optical connection.
- **PCM 7.1** — Sends a PCM audio signal of up to 7.1 channels over the HDMI connection and up to 2 channels over the optical connection.

### Dynamic Range Control:

**Dynamic Range Control** means that you can allow the BD player to make the loud parts of a movie's audio track quieter than they would be in the theatre, without making the dialog of the actors any quieter.

This would be useful, for instance, when you want to watch a movie in the evening when others might be sleeping.

**NOTES:** This setup menu item **has no effect** unless:

- The device playing the disk's audio (TV or surround audio receiver) is connected to the BD player's analog audio outputs; OR
- you have selected "Bitstream Mixed" in the BD player's audio setup menu.

When **Dynamic Range Control** is set to **Off**, movie soundtracks are played with the standard dynamic range.

When movie soundtracks are played at low volume or from smaller speakers, you can set **Dynamic Range Control** to **On**. Your player applies appropriate compression to make low-level content more intelligible and prevent dramatic passages from getting too loud.

Selecting the "**Auto**" option turns on the Dynamic Range Control for all BD movie soundtracks except Dolby TruHD. If you have selected a TruHD track on the BD disk, the "auto" selection tells the BD player to only turn on dynamic range control if information embedded in the TruHD sound track tells it to do so.

## Customizing the Function Settings

### Speaker Setting

Once the speakers are connected to the system and properly configured, you can check to verify that the connections to the speakers are correct by running an audio speaker test.

To run this test, follow the instructions described as below:

1. In the main menu of **Settings**, press **▶** button, then use **▲ / ▼** button to select **Speaker**, then press **OK**.

**Note:** This setup menu item has no effect unless:

- If you have selected 'Bitstream Mixed' in the audio menu, these menu choices will have no effect. (Each channel's full audio spectrum will be sent to each speaker, regardless of the speaker size selected)
  - If you don't know the type of speakers attached to your surround sound system, consult the manual for your speaker system.
2. Use **▼ / ▲ / ▶ / ◀** to highlight the desired speaker, then press **OK** to enter.
  3. Press **▼ / ▲** to choose the desired audio signal, and then press **OK** to confirm.

#### Front Left & Right Speakers:

- By setting the front left speaker's size, the front right speaker's size is automatically changed to match.
- The front speakers can not be turned off. They can only be set to '**Small**' or '**Large**'.

#### Center Speaker:

- If the front speakers have been set to small, the center speaker can only be set to '**small**' or '**Off**'.
- Setting a speaker to 'off' will result in no sound being delivered to that speaker.

#### Subwoofer:

- If you don't know the crossover frequency of your subwoofer, consult the manual for your speaker system.

#### Surround Left & Right Speakers:

- By setting the left surround speaker's size, the right surround speaker's size is automatically changed to match.
- If the front speakers have been set to small, the surround speakers can only be set to '**Small**' or '**Off**'.

#### Rear Left & Right Speakers:

- By setting the left rear speaker's size, the right rear speaker's size is automatically changed to match.
- If the front speakers have been set to small, the rear speakers can only be set to '**Small**' or '**Off**'.

4. Use **▼ / ▲ / ▶ / ◀** to move the highlight box to the **Test** button on the bottom, then press **OK**. A message will appear.

5. Press **▼ / ▲** to choose the desired audio signal. You can select between Pink, 1kHz Sine and White.
6. Press **OK** to begin the speaker test. The audio signal will be sent to a different speaker every approximately every two seconds. The audio test will highlight which speaker is supposed to be getting the sound on the screen.
7. To stop the audio test, press one of the **▼ / ▲ / ▶ / ◀** buttons.
8. Press **◀** or **RETURN** to go to the previous menu.



## Customizing the Function Settings

### Language Setting

1. In the main menu of **Settings**, press **▲ / ▼** to select **Language**, and then press **OK**.

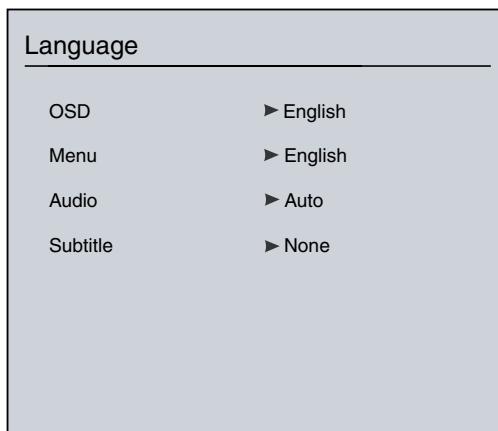

2. Press **▲ / ▼** to select **OSD**, **Menu**, **Audio** or **Subtitle**, and then press **OK**.
3. Use **▲ / ▼** to select your preferred language, and then press **OK** to confirm your selection.
4. Press **◀** to go to the previous menu.

#### OSD:

This option enables you to select the on-screen menu language.

#### Menu:

This option lets you to select the disc menu language.

#### Notes:

- Not all languages are available on all discs.
- Most discs only have one menu language.

#### Audio:

You can choose the audio language from this option to your preference.

#### Notes:

- Not all languages are available on all discs.
- Some discs do not let you select the audio language using your player's menu. Instead, you have to select the audio language from the disc setup menu (the menu that appears after you insert the disc).

#### Subtitle:

You can customize your preferred subtitle language in this option.

#### Notes:

- Not all languages are available on all discs.
- Some discs do not let you select the audio language using your player's menu. Instead, you have to select the audio language from the disc setup menu (the menu that appears after you insert the disc).
- You can also select the subtitle language from the subtitle menu in the on-screen menu.

### Parental Control

1. In the main menu of **Settings**, press **▶**, then press **▲ / ▼** to select **Parental**, and then press **OK**.

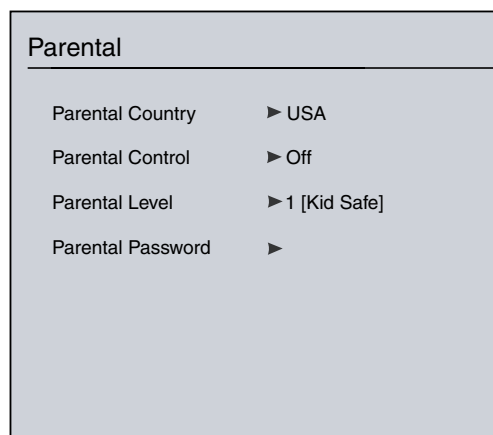

Function setup

2. Press **▲ / ▼** to select **an option**, and then press **OK**.
3. Use **▲ / ▼** to select the desired option, and then press **OK** to confirm your selection.
4. Press **◀** to go to the previous menu.

**Note:** If **Parental Control** was previously turned **On**, you will be prompted to enter the parental control password before being allowed to change these settings. (See “**Turning parental control on or off**” on page 34 for details.)

### Selecting the parental country

If a Blu-ray Disc has parental rating systems for more than one country, you can select the country you want to use.

1. In the main menu of **Settings**, press **▶**, then press **▲ / ▼** to select **Parental**, and then press **OK**.
2. While the highlight bar is moved on **Parental Country**, then press **OK**.
3. Press **▲ / ▼** to select the desired country, then press **OK**.
4. Press **◀** to go to the previous menu.

## Customizing the Function Settings

### Turning parental control on or off

1. In the main menu of **Settings**, press **▶**, then press **▲/▼** to select **Parental**, and then press **OK**.
2. Press **▲/▼** to select **Parental Control**, then press **OK**.
3. Press **▲/▼** to select **On** or **Off**, then press **OK**.
4. Press **◀** to go to the previous menu.

### Setting the parental control level

1. In the main menu of **Settings**, press **▶**, then press **▲/▼** to select **Parental**, and then press **OK**.
2. Press **▲/▼** to select **Parental Level**, then press **OK**.
3. Press **▲/▼** to select the rating level you want to block, then press **OK**. The rating and all higher ratings will be blocked. You can select:
  - 1 [Kid Safe] — Suitable for all children.
  - 2 [G] — General audiences.
  - 3 [PG] — Parental guidance suggested.
  - 4 [PG-13] — Not suitable for anyone under 13.
  - 5 [PG-R] — Parental guidance recommended.
  - 6 [R] — Not suitable for anyone under 17 unless supervised by a parent or adult guardian.
  - 7 [NC-17] — Not suitable for anyone under 17.
  - 8 [Adult] — All DVDs can be played.

**Note:** These ratings are only for DVDs.

4. Press **◀** to go to the previous menu.

### Setting the parental control password

1. In the main menu of **Settings**, press **▶**, then press **▲/▼** to select **Parental**, and then press **OK**.
2. Press **▲/▼** to select **Parental Password**, then press **OK**.
3. Enter a 4-digit number for the parental password, then use **▼** to highlight **OK**, and then press **OK** to confirm.  
If you forget your password, reset your player to the factory defaults. For more information, see **"Restore factory defaults"** on page 35.
4. Press **◀** to go to the previous menu.

## System Setting

1. In the main menu of **Settings**, press **▶** button, then use **▲/▼** button to select **System**, then press **OK**.

### System

Optical Disc Auto Play	▶ On
BD-Live Internet Access	▶ Always Allow Access
BD-Live Storage	▶ USB (1.9GB Free)
Erase Blu-ray Storage	
Time Zone	▶ CST (GMT-06:00)
Screen Saver Duration	▶ 5 Minutes
CEC Support	▶ On
Update Via Network	▶ Required Storage: 84 MB
Restore factory defaults	▶

2. Press **▲/▼** to select an option, and then press **OK**.
3. Use **▲/▼** to select the desired setting, and then press **OK** to confirm.
4. Press **◀** to go to the previous menu.

### Optical Disc Auto Play:

If **On** is selected, it will load data and play back automatically when you insert a Blu-ray disc. When **Off** is selected and if you insert a Blu-ray disc, the disc you can select will be displayed on the Settings menu.

### BD-Live Internet Access:

- **Limit Access** — Allows Internet access with valid "BD-Live" network access approval.
- **Always Allow Access** — Always allows BD-Live Internet access.
- **Prohibit Access** — Never allows BD-Live Internet access.

### BD-Live Storage:

This option is used to tell the BD player whether or not to use an inserted SD card or USB device to store BD-Live content (movie trailers, additional scenes, etc.).

For detailed operation, please refer to **"Using BD-Live™ Features"** on page 38.

### Erase Blu-ray Storage:

If you choose **OK** to erase Blu-ray storage, all bookmarks and BD-Live content saved in memory are deleted.

### Time Zone:

This option allows you to select the desired time zone.

## Customizing the Function Settings

### Screen Saver Duration:

This Blu-ray disc player has a screen saver feature that turns the screen black when your player is inactive. You can set the interval time you want your player to wait before activating the screen saver.

### CEC Support:

This option is used to allow the TV remote control to control certain functions of the Blu-ray disc player; and for the Blu-ray player to control certain functions of the TV.

**Note:** Not all TVs are compatible with your Blu-Ray Player.

**On:** Allow mutual control of devices through HDMI.

**Off:** Do not allow CEC control.

### Update Via Network:

This option displays the required storage space if the BD player is connected to internet for upgrade.

For detailed upgrade operation, please refer to “**Upgrading Your Player’s Firmware**” on this page.

### Restore factory defaults:

Choose one of the following 7 options, then press **OK** to pop up a dialog box, choose **OK** in the box, and then press **OK** to confirm.

To apply the deactivation, please plug off the player after operating deactivation.

Actions	Response
Restore factory settings and deactivate all connected applications	All settings (including Parental Password) will be restored to the factory defaults and all connected applications will be deactivated.
Restore factory settings	Restores all settings (including Parental Password) to the factory defaults.
Deactivate all connected applications	Deactivates all connected applications (Netflix / Pandora / Blockbuster / VUDU)
Deactivate Netflix	Deactivates the connected Netflix application
Deactivate Pandora	Deactivates the connected Pandora application
Deactivate VUDU	Deactivates the connected VUDU application
Deactivate Blockbuster	Deactivates the connected Blockbuster application

## Upgrading Your Player’s Firmware

The company that produced this player may occasionally offer upgrades to the player’s software.

### Automatic upgrades over the Internet

1. Make sure that your player is successfully connected to the Internet. If new software is available, you will see a message prompting you whether to update your firmware.
2. If you want to update the player’s firmware, use **▶ / ◀** to highlight “OK”, and then press **OK**. The software will begin downloading, and a status bar will appear on the TV screen.
3. Once the update is complete, a message will appear indicating that the player will turn itself off and on.

## Using the Connected Applications

Some players are equipped with the capability to watch movies over the internet (from Blockbuster, Netflix or Vudu), or to listen to Pandora internet radio.

### Watching Movies with Netflix™

To use Netflix service, connect this player to your network, and make the network settings if they are not finished yet.

#### 1. Launching Netflix movie

In Home Menu, press ▲ / ▼ to select **Connected**, then use ►, and then press ▲ / ▼ to highlight “Netflix”, and then press **OK** to enter.

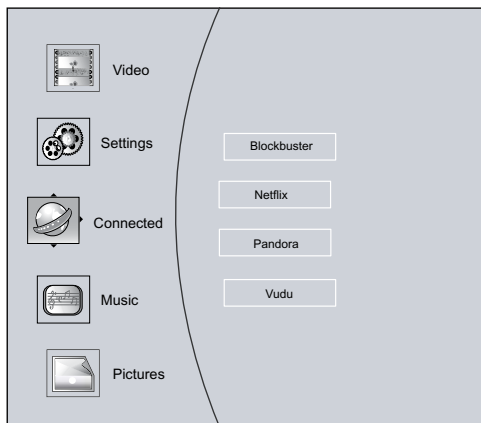

#### 2. Creating Netflix account

If you are not a Netflix Member:

Select “no”. Read the instructions displayed on the TV screen, and visit <http://www.netflix.com/toshiba> from your PC. Sign up to create your account, then select “I’m now a member”.



If you are a Netflix Member:

Select “Yes”.

#### 3. Activating Netflix player

To play streaming video via Netflix service, Netflix player needs to be activated. Read the instructions displayed on the TV screen, and visit <http://www.netflix.com/activate> on your PC. Sign in to your Netflix account, if necessary. Enter the activation code displayed on the TV screen.



#### 4. Preparing Instant Queue

To play streaming video via Netflix service, Netflix player needs to be activated. Read the instructions displayed on the TV screen, and visit <http://www.netflix.com/activate> on your PC. Sign in to your Netflix account, if necessary. Enter the activation code displayed on the TV screen.

**Now you can view Netflix streaming video.**

After having activated Netflix player and prepared Instant Queue, movies and TV episodes in your Instant Queue appear on the TV screen. Select your desired one using the remote control of the player. You can control Netflix streaming video with the following keys of the remote control of this player:

▶	To start playing movie. To pause playback while in PLAY mode.
■	To stop playing and return to a list of movie titles.
	To pause playing movie. To start playing while in PAUSE mode.
▶	To pause playing and open a list of scenes. Pressing further proceeds to the next scene.
◀	To pause playing and open a list of scenes. Pressing further proceeds to the previous scene.
▲	To stop playing and return to a list of movie titles.
▶▶	To pause playing and open a list of scenes. Fast forward play starts.
◀◀	To pause playing and open a list of scenes. Fast reverse play starts.
HOME MENU	To stop playing and return to Home Menu.
OK	To pause playing of Trick play screen while in PLAY mode. To start playing the movie in case of during Trick play screen.

**Note:** Resolution of video streamed from Netflix varies depending on communication speed or bitrate of each content, etc.

## Using the Connected Applications

### Watching Movies with BLOCKBUSTER®

This Blu-ray Disc Player enables you to use the following services provided by Blockbuster.

1. In Home Menu, press ▲ / ▼ to select **Connected**.
2. Press ►, then press ▲ / ▼ to highlight **Blockbuster**, and then press **OK** to enter Blockbuster main menu.
  - **Movies** : Display movies.
  - **TV Shows** : Display TV Shows.
  - **Find** : Search for a desired movie or TV show by entering it manually.
  - **My Library** : Display a title that you bought or rented.
  - **My Favorites** : Displays a title that has been added to My Favorites.
  - **Configure** : Activate or deactivate the Blu-ray Disc Player.
  - **Help** : Get customer service contact information and check the current software version.
3. If you don't have a Blockbuster account yet, visit [www.blockbuster.com](http://www.blockbuster.com) to create your account.
4. Use ▼ / ▲ / ► / ◀ to select the **Configure**, then press **OK**.
5. Use the number buttons on the remote control to enter the activation code that is created by the web site, then use ▼ to highlight **Activate**, and press **OK** to confirm.

When the Blu-ray Disc Player is activated, you will move to the Home page.
6. Press ► / ◀ to select the **Movies** or **TV Shows**, then press **OK**.
7. Press ▼ / ▲ / ► / ◀ to select the desired title, then press **OK**.
8. Press ► / ◀ to select the **Rent** or **Buy**, then press **OK**.
9. Press ► / ◀ to select the **Submit Order**, then press **OK**. If you want to play any of the titles that your bought, simply click **Play Now**.
10. Press ◀ to go to the previous menu.

### Watching Movies with VUDU™

#### Creating a VUDU account on your player

1. In Home Menu, press ▲ / ▼ to select **Connected**.
2. Press ►, then press ▲ / ▼ to highlight **Vudu**, and then press **OK** to confirm.
3. Follow the instructions to create an account, it will ask for an email address.
4. Enter YOUR email address using the keyboard that appears on the screen. VUDU will then display a message on the TV **"Sending you an email"**.

#### Creating a VUDU account on your PC

1. VUDU will send you an email with a hyper-link; click on the link.
2. In the Vudu page that comes up on your PC's browser after clicking the link, enter the e-mail and password of the owner of the account.
3. VUDU will then display a message **"Enabling your device to view movies. The email message on your TV screen will disappear when done"**.
4. On your TV, you can now navigate to a VUDU movie, and 'buy' or 'rent' it.

## Using the Connected Applications

### Listening to Music with PANDORA™

#### Using an existing Pandora account

1. In Home Menu, press ▲ / ▼ to select **Connected**.
2. Press ►, then press ▲ / ▼ to highlight **Pandora**, and then press **OK** to confirm.
3. Select **"I have a Pandora account"** from the option list.
4. Sign in with your test account.

#### Creating a new account on the BD player

1. In Home Menu, press ▲ / ▼ to select **Connected**.
2. Press ►, then press ▲ / ▼ to highlight **Pandora**, and then press **OK** to confirm.
3. Select **"I am new to Pandora"** from the option list.
4. You will be given an activation code. Use this activation code to generate a new account and link it to the BD player using a PC.

#### Creating a new Pandora account on your PC

Go to <http://www.pandora.com/> to create a new account.

## Using BD-Live™ Features

Some (but not all) BD disks contain additional features that are made available to players that are connected to the internet, and have additional memory added. These additional features may include things like:

- the ability to download new movie trailers
- additional 'commentary' by actors and directors
- multiperson game play and chat

In order to access BD-Live functions, the player must be properly configured for BD-Live internet access, and it must be equipped with additional memory.

#### Adding BD-Live memory to the player

In order to set the player up for BD-Live Internet Access, insert an USB device or SD card (1GB is recommended) into the USB slot or SD card slot on the player.

#### Configuring the player for BD-Live internet access

In order to set the player up for BD-Live Internet Access, perform the following steps:

1. In the main menu of **Settings**, press ► button, then use ▲ / ▼ to select **System**, then press **OK**.
2. Press ▲ / ▼ to select **"BD-Live Internet Access"**, and then press **OK**.
3. Use ▲ / ▼ to select the desired setting, and then press **OK** to confirm.
4. Make sure that **"Limit Access"** or **"Always Allow Access"** is checked.
5. Once the USB device or SD card has been inserted, if there is not at least 100Mbyte of free space on the device, you should choose **"Erase Blu-ray Storage"** from the System setup menu.
6. Press ◀ to return to the main menu of **Settings**, then use ▲ / ▼ to highlight **Network**, and then press **OK**. (For details, please refer to "Network Connection Setting" on Page 29.)

#### Note:

- Depending on your connection environment, it may take time to connect to the Internet or the Internet may not be connected.
- When BD-Live function are used and the unit is connected to the Internet, you may be charged for this communication.
- Do not remove the USB device or SD card when using the BD-Live function.

# Troubleshooting & Maintenance

## Troubleshooting

If the unit does not perform properly when operated as instructed in this manual, check the unit, consulting the following checklist.

Problem	Solution
No power	<ul style="list-style-type: none"> <li>- Check if the AC cord is properly connected.</li> <li>- Unplug the AC cord once, and wait for 5-10 seconds and then plug it in again.</li> </ul>
No sound or picture	<ul style="list-style-type: none"> <li>- Check if the connected TV is turned on.</li> <li>- Check if the connections are made securely and correctly.</li> <li>- Check whether the connected TV or other device supports HDCP. (This unit will not output a video signal unless the other device supports HDCP.)</li> <li>- Check whether the output format of this unit (HDMI FORMAT) matches the supported input format of other connected device.</li> </ul>
Distorted picture	<ul style="list-style-type: none"> <li>- Sometimes a small amount of picture distortion may appear. This is not a malfunction.</li> <li>- Connect this unit directly to the TV. If the composite audio / video cables are connected to a VCR, pictures may be distorted due to the copyright protection system.</li> </ul>
Completely distorted picture or black / white picture with BD / DVD	<ul style="list-style-type: none"> <li>- Make sure the disc is compatible with this unit.</li> </ul>
No sound or distorted sound	<ul style="list-style-type: none"> <li>- Adjust the volume.</li> <li>- Check if speakers are connected correctly.</li> <li>- Check the HDMI connections.</li> <li>- Check the settings in "Audio" menu.</li> </ul>
Picture freezes momentarily during playback	<ul style="list-style-type: none"> <li>- Check the disc for fingerprints / scratches and clean with a soft cloth wiping from center to edge.</li> <li>- Clean the disc.</li> </ul>
Disc cannot be played back	<ul style="list-style-type: none"> <li>- Clean the disc.</li> <li>- Ensure the disc label is facing up.</li> <li>- Check if the disc is defective by trying another disc.</li> <li>- Cancel the ratings control or change the control level.</li> <li>- Insert a correct disc that can be played back on this unit.</li> </ul>
SD Memory Card cannot be read	<ul style="list-style-type: none"> <li>- The format of the card does not match that accepted by this unit or the card is not compatible.</li> </ul>
No return to start-up screen when disc is removed	<ul style="list-style-type: none"> <li>- Reset this unit by turning it off, then on again.</li> </ul>
The unit does not respond to the remote control	<ul style="list-style-type: none"> <li>- Aim the remote control directly at infrared sensor window on the front panel.</li> <li>- Reduce the distance to infrared sensor window.</li> <li>- Replace the batteries in the remote control.</li> <li>- Re-insert the batteries with their polarities (+ / - signs) as indicated.</li> </ul>
Buttons do not work or the unit stops responding	<ul style="list-style-type: none"> <li>- To completely reset the unit, unplug the AC cord from the AC outlet for 5-10 seconds.</li> </ul>
The unit does not respond to some operating commands during playback	<ul style="list-style-type: none"> <li>- Operations may not be permitted by the disc. Refer to the instructions of the disc.</li> </ul>
The unit cannot read BD / DVD/ CD	<ul style="list-style-type: none"> <li>- Dew condensation may form inside the unit. Do not use this unit for at least a few hours until its inside gets dry.</li> <li>- Wipe the dirt off the disc or replace the disc.</li> </ul>
Angle does not switch	<ul style="list-style-type: none"> <li>- The angle cannot be switched for BD / DVD which do not contain multiple angles. In some cases multiple angles are only recorded for specific scenes.</li> </ul>
Playback does not start when the title is selected	<ul style="list-style-type: none"> <li>- Check the settings in "Parental" menu.</li> </ul>

Others

## Troubleshooting & Maintenance

Problem	Solution
The password for rating level has been forgotten	- If you forget your password, reset your player to the factory defaults and your forgotten password will be cleared. For more information, see "Restore factory defaults" on page 35.
Cannot connect to the network	- Check if the LAN cable connection is properly made. - Turn on the modem or broadband router. - Check if the broadband router and/or modem is correctly connected. - Check the "Network Connection Setting".
Cannot connect to the network while my PC is connected to the network	- Check the content of your Internet service contract to see if your Internet service provider prevents multiple terminals connecting at the same time.
Cannot use the BD-Live function	- Use an SD card with enough space.
The playback of BD-video or download of data does not perform properly	- Check if an SD Card is correctly inserted. Do not remove the card during playback as some BD-videos require an SD Card during playback.

### Notes

- Some functions are not available in specific modes, but this is not a malfunction. Read the description in this manual for details on correct operations.
- Some functions are prohibited on some discs.

## Maintenance

### Servicing

- Please refer to relevant topics on "Troubleshooting & Maintenance" before returning the product.
- If this unit becomes inoperative, do not try to correct the problem by yourself. There are no user-serviceable parts inside. Turn off, unplug the power plug, and please call our helpline to locate an Authorized Service Center.

### Cleaning the cabinet

- Never use a solvent, thinner, benzene or alcohol to clean the unit. Do not spray insecticide liquid near the unit. Such chemicals may discolor the surface or damage the unit.

### Cleaning discs

- When a disc becomes dirty, clean it with a cleaning cloth. Wipe the disc from the center to out. Do not wipe in a circular motion.
- Do not use solvents such as benzene, thinner, commercially available cleaners, detergent, abrasive cleaning agents or antistatic spray intended for analog records.

### Cleaning the disc lens

- If this unit still does not perform properly although you refer to the relevant sections and to "Troubleshooting" in this manual, the laser optical pickup unit may be dirty. Consult your dealer or an Authorized Service Center for inspection and cleaning of the laser optical pickup unit.

### Disc handling

- Handle the discs so that fingerprints and dust do not adhere to the surfaces of the discs.
- Always store the disc in its protective case when it is not used.
- Note that discs with special shapes (heart-shaped discs, octagonal discs, etc.) cannot be played back on this unit. Do not attempt to playback such discs, as they may damage the unit.

### IR signal check

- If the remote control is not working properly, you can use a digital camera (including a cellular phone with built-in camera) to see if it is sending out an infrared signal.





## Glossary

### Analog Audio

An electrical signal that directly represents sound. Compare this to digital audio which can be an electrical signal, but is an indirect representation of sound.

### Aspect Ratio

The width of a TV screen relative to its height. Conventional TVs are 4:3 (in other words, the TV screen is almost square); widescreen models are 16:9 (the TV screen is almost twice as wide as it is high).

### AVCHD

AVCHD is a new format for high definition video camcorders which can record and play high-resolution HD images.

### BD-Java

With some BD which support Java applications, you can enjoy the interactive functions such as games or interactive menus.

### BD-Live

BD-Live is a BD-video (BD-ROM version 2 Profile 2.0/Profile 1.1) which contains new functions (e.g. Internet connection), in addition to the BONUSVIEW function.

### Blu-ray Disc (BD)

Blu-ray Disc is a next generation optical video disc which is capable of storing much more data than a conventional DVD is. The large capacity makes it possible to benefit from the features such as high-definition videos, multi-channel surround sounds, interactive menus and so on.

### Chapter

Just as a book is split up into several chapters, a title on a BD-video or DVD-video is usually divided into chapters.

### Component Video Output

Each signal of luminance (Y) and component ( $P_B/C_B$ ,  $P_R/C_R$ ) is independent to output so that you can experience picture Color as it is.

Also, due to compatibility with progressive video (525p/480p), you can experience higher-density picture than that in interlace (525i/480i).

### Digital Audio

An indirect representation of sound by numbers. During recording, the sound is measured at discrete intervals (44,100 times a second for CD audio) by an analog-to-digital converter, generating a stream of numbers. On playback, a digital-to-analog converter generates an analog signal based on these numbers.

### DNS Server

A server which translates Internet domain names into IP addresses.

### Dolby Digital

The system to compress digital sound developed by Dolby Laboratories. It offers you sound of stereo (2ch) or multi-channel audio.

### Dolby Digital Plus

Dolby Digital Plus is the next generation digital audio compression technology developed as an extension to Dolby Digital. Blu-ray Disc supports 7.1 multi-channel surround sound output.

### Dolby TrueHD

Dolby TrueHD is a lossless coding technology developed for next generation optical discs. Blu-ray Disc supports 7.1 multi-channel surround sound output.

### DTS (Digital Theater System)

DTS is a multi-channel surround sound system. By connecting to DTS decoder, you can enjoy movie dynamic and realistic sound like movie theater. DTS surround sound technologies were developed by DTS, Inc.

### DTS-HD

DTS-HD is a lossless coding technology developed as an extension of the original DTS Coherent Acoustics format. Blu-ray Disc supports 7.1 multi-channel surround sound output.

### Gateway

IP Address of the electronic devices (such as router) which provide Internet access.

### HDMI (High-Definition Multimedia Interface)

A digital interface between audio and video source. It can transmit component video, audio, and control signal with one cable connection.

### Hub

A device used for connecting multiple device to the network.

### IP Address

A set of numbers which are assigned to devices participating in a computer network.

### JPEG (Joint Photographic Experts Group)

JPEG is a method of compressing still picture files. You can copy JPEG files on BD-RE/-R, DVD-RW/-R, CD-RW/-R or SD Memory Card from a computer and play back the files in this unit.

### LAN (Local Area Network)

A group of computer networks covering a small area like a company, school or home.

## Glossary

### **Local Storage**

---

A storage area of sub contents for playing virtual packages on BD-video.

### **MP3 (MPEG audio layer 3)**

---

MP3 is a method of compressing files. You can copy MP3 files on BD-RE/-R, DVD-RW/-R, CD-RW/-R or SD Memory Card from the computer and play back the files on this unit.

### **PCM (Pulse Code Modulation)**

---

The most common system of encoding digital audio, found on CD and DAT. Excellent quality that requires a lot of data compared to formats such as Dolby Digital and MPEG audio. For compatibility with digital audio recorders (CD, MD and DAT) and AV amplifiers with digital inputs, this unit can convert Dolby Digital, DTS, and MPEG audio to PCM.

### **Proxy Server**

---

Proxy server is a server which acts as an intermediary between a workstation user and the Internet to ensure security.

### **Region Code**

---

Regions associate discs and players with particular areas of the world. This unit will only play back discs that have compatible region codes. You can find the region code of your unit by looking on the rear panel. Some discs are compatible with more than one region (or all regions).

### **Router**

---

A networking device which distinguishes the IP address assigned to each device and routing and forwarding information in the computer network.

### **Sampling Frequency**

---

The rate which sound is measured by a specified interval to turn into digital audio data. The numbers of sampling in one second defines as sampling frequency. The higher the rate, the better the sound quality.

### **Subnet Mask**

---

A mask which is used to determine what subnet an IP address belongs to.

### **Title**

---

A collection of chapters on BD-video or DVD-video.

### **Track**

---

Audio CD use tracks to divide up the content of a disc. The BD-video or DVD-video equivalent is called a chapter. See also "Chapter".

### **Virtual Package**

---

The function which copies data to other media (local storage) from the Internet and play the secondary video, secondary audio and the subtitle at the same time. The method of the playback varies depending on discs.

### **Windows Media™ Audio**

---

Windows Media™ Audio is the audio compressing technology developed by Microsoft. You can copy Windows Media™ Audio files on BD-RE/-R, DVD-RW/-R, CD-RW/-R or SD Memory Card from a computer and play them back on this unit.

### **x.v.Color**

---

"x.v.Color" is a promotion name given to the products that have the capability to realize a wide color space based on the xvYCC specifications and is a trademark of Sony Corporation.

# Specifications

General	
Signal system	NTSC color
Power requirements	120 V AC, 60 Hz
Power consumption	23 W
Dimensions (width x height x depth)	430 x 58.5 x 209.7 mm
Weight	1.7 kg
Operating temperature	41°F (5°C) to 95°F (35°C)
Operating humidity	Less than 80 % (no condensation)

Terminals		
Rear	<b>Video output</b> RCA jack	1 Vp-p (75Ω)
	<b>Component video output</b> RCA jack x 3	Y: 1 Vp-p (75Ω)    P <sub>B</sub> /C <sub>B</sub> : 700 mVp-p (75Ω)    P <sub>R</sub> /C <sub>R</sub> : 700 mVp-p (75Ω) Video: 480i, 480p, 720p, 1080i
	<b>HDMI output</b> HDMI jack x 1	Video: 480i, 480p, 720p, 1080i, 1080p, 1080p/24F / Audio
	<b>Audio output (Analog)</b> RCA jack x 2	L/R: 2 Vrms (output impedance: less than 1kΩ)
	<b>Audio output (Digital)</b> Optical jack x 1	Digital connector
	<b>Multi channel audio output</b> RCA jack x 8	All channels: 2 Vrms (output impedance: less than 1kΩ)
	<b>USB terminal x 1</b>	5V --- 500mA
	<b>LAN terminal</b>	100BASE-T

Others

**Note:**

- The specifications and design of this product are subject to change without notice.

## Limited United States Warranty

### Digital Audio Video ("DAV") Product - Exchange Warranty

Toshiba America Consumer Products, L.L.C. ("TACP") makes the following limited warranties to original consumers in the United States.

THESE LIMITED WARRANTIES EXTEND TO THE ORIGINAL CONSUMER PURCHASER OR ANY PERSON RECEIVING THIS DAV PRODUCT AS A GIFT FROM THE ORIGINAL CONSUMER PURCHASER AND TO NO OTHER PURCHASER OR TRANSFEREE.

DAV PRODUCTS PURCHASED IN THE U.S.A. AND USED ANYWHERE OUTSIDE OF THE U.S.A., INCLUDING, WITHOUT LIMITATION, CANADA AND MEXICO, ARE NOT COVERED BY THESE WARRANTIES.

DAV PRODUCTS PURCHASED ANYWHERE OUTSIDE OF THE U.S.A., INCLUDING, WITHOUT LIMITATION, CANADA AND MEXICO, AND USED IN THE U.S.A., ARE NOT COVERED BY THESE WARRANTIES.

### Limited Warranty

TACP warrants this DAV Product and its parts against defects in materials or workmanship for a period of ninety (90) days after the date of original retail purchase.

**DURING THIS PERIOD, TACP WILL EXCHANGE A DEFECTIVE DAV PRODUCT WITH A NEW OR REFURBISHED DAV PRODUCT WITHOUT CHARGE TO YOU. DURING THE PERIOD THAT COMMENCES ON THE DATE THAT IS NINETY ONE (91) DAYS AFTER THE DATE OF ORIGINAL RETAIL PURCHASE AND ENDS ON THE DATE THAT IS THREE HUNDRED SIXTY FIVE (365) DAYS AFTER THE DATE OF ORIGINAL RETAIL PURCHASE, TACP WILL EXCHANGE A DEFECTIVE DAV PRODUCT WITH A NEW OR REFURBISHED DAV PRODUCT FOR A FEE.**

### Rental Units

The warranty for DAV Product rental units begins on the date of the first rental or thirty (30) days after the date of shipment to the rental firm, whichever comes first.

### Commercial Units

DAV Products sold and used for commercial purposes have a limited warranty for all parts and labor, which warranty begins on the date of original retail purchase and ends on the date that is ninety (90) days thereafter.

### Owner's Manual and Product Registration Card

Read this owner's manual thoroughly before operating this DAV Product. Complete and mail the enclosed product registration card or register your DAV Product on-line at [www.tacp.toshiba.com/service](http://www.tacp.toshiba.com/service) as soon as possible. By registering your DAV Product you will enable TACP to bring you new products specifically designed to meet your needs and help us to contact you in the unlikely event a safety notification is required under the U.S. Consumer Product Safety Act. Failure to complete and return the product registration card does not diminish your warranty rights.

### Your Responsibility

THE ABOVE WARRANTIES ARE SUBJECT TO FOLLOWING CONDITIONS:

- (1) You must retain your bill of sale or provide other proof of purchase.
- (2) All warranty servicing of this DAV Product must be made pursuant to the TACP DAV Product Warranty Exchange Program.
- (3) The warranties from TACP are effective only if the DAV Product is purchased and operated in the Continental U.S.A. or Puerto Rico.
- (4) Labor service charges for set installation, setup, adjustment of customer controls, and installation or repair of antenna systems are not covered by this warranty. Reception problems caused by inadequate antenna systems are your responsibility.
- (5) Warranties extend only to defects in materials or workmanship as limited above, and do not extend to any DAV Product or parts that have been lost or discarded by you or to damage to the DAV Product or parts caused by fires, misuse, accident, Acts of God (such as lightning or fluctuations in electric power), improper installation, improper maintenance, or use in violation of instructions furnished by TACP; use or malfunction

through simultaneous use of this DAV Product and connected equipment; or to units that have been modified or had the serial number removed, altered, defaced, or rendered illegible.

- (6) This warranty does not cover Product sold AS IS or WITH ALL FAULTS.

### How to Obtain Warranty Services

If, after following all of the operating instructions in this manual and checking the section "Before Calling Service Personnel," you find that service is needed:

- (1) For instructions on how to obtain warranty service for your DAV Product under the TACP DAV Product Warranty Exchange Program, contact TACP's Consumer Solutions Center toll free at 1-800-631-3811.
- (2) You must include the original bill of sale (or a copy of the original bill of sale) or other proof of purchase along with the entire DAV Product when sending the DAV Product to the TACP Warranty Exchange Center specified by TACP's Consumer Solutions Center. You are responsible for all inbound transportation and insurance charges for the DAV Product to the TACP Warranty Exchange Center.

For additional information, visit TACP's website: [www.tacp.toshiba.com](http://www.tacp.toshiba.com)

**ALL WARRANTIES IMPLIED BY THE LAW OF ANY STATE OF THE U.S.A., INCLUDING THE IMPLIED WARRANTIES OF MERCHANTABILITY AND FITNESS FOR A PARTICULAR PURPOSE, ARE EXPRESSLY LIMITED TO THE DURATION OF THE LIMITED WARRANTIES SET FORTH ABOVE. WITH THE EXCEPTION OF ANY WARRANTIES IMPLIED BY THE LAW OF ANY STATE OF THE U.S.A. AS HEREBY LIMITED, THE FOREGOING WARRANTY IS EXCLUSIVE AND IN LIEU OF ALL OTHER WARRANTIES, GUARANTEES, AGREEMENTS, AND OF ALL OTHER WARRANTIES, GUARANTEES, AGREEMENTS, AND OR REPLACEMENT OF ANY PARTS. IN NO EVENT SHALL TACP BE LIABLE FOR CONSEQUENTIAL OR INCIDENTAL DAMAGES (INCLUDING, BUT NOT LIMITED TO, LOST PROFITS, BUSINESS INTERRUPTION, OR MODIFICATION OR ERASURE OF RECORDED DATA CAUSED BY USE, MISUSE OR INABILITY TO USE THIS DAV PRODUCT).**

No person, agent, distributor, dealer, or company is authorized to change, modify, or extend the terms of these warranties in any manner whatsoever. The time within which an action must be commenced to enforce any obligation of TACP arising under the warranty or under any statute or law of the United States or any state thereof is hereby limited to ninety (90) days from the date you discover, or should have discovered, the defect. This limitation does not apply to implied warranties arising under state law.

**THIS WARRANTY GIVES YOU SPECIFIC LEGAL RIGHTS AND YOU MAY ALSO HAVE OTHER RIGHTS WHICH MAY VARY FROM STATE TO STATE IN THE U.S.A. SOME STATES OF THE U.S.A. DO NOT ALLOW LIMITATIONS ON HOW LONG AN IMPLIED WARRANTY LASTS, WHEN AN ACTION MAY BE BROUGHT, OR THE EXCLUSION OR LIMITATION OF INCIDENTAL OR CONSEQUENTIAL DAMAGES, SO THE ABOVE PROVISIONS MAY NOT APPLY TO YOU UNDER SUCH CIRCUMSTANCES.**

## Disclaimer

BDX2500 requires a wireless adapter - sold separately.

Up-conversion of DVD content will result in near HD picture quality. 1080p capable display required for viewing in 1080p. Feature performance may vary and may also require an always-on broadband internet connection. Firmware update and additional bandwidth may be required. BD-Live™ may require an SD or SDHC card with available storage capacity of at least 1GB. Internet services available only in the United States. Third party internet services are not provided by Toshiba, may change or be discontinued at any time and may be subject to third party restrictions. Toshiba makes no representations or warranties about these services, which may require the creation of a user account through a computer with internet access. Third party internet service users may incur one-time and/or recurring charges. For Dolby® TrueHD and DTS-HD Master Audio | Essential™ playback, content encoded in Dolby® TrueHD and DTS-HD Master Audio | Essential™ format required. Viewing 1080p/24 fps output requires 1080p/24 fps encoded content and an HD display capable of accepting a 1080p/24Hz signal. Supported file types: JPEG, MP3, WMA, and AVCHD. Some recordable media, cards or files may not be supported. Product specifications, information and availability are all subject to change without notice.

## License information on the software used in the TOSHIBA BD player

This document is statement purpose only. Not concerned with operation of this product.

The software pre-installed in the TOSHIBA BD player consists of multiple, independent software components. Each software component is copyrighted by TOSHIBA or a third party.

The TOSHIBA BD player uses software components that are distributed as freeware under a third-party end-user license agreement or copyright notice (hereinafter referred to as a "EULA").

Some EULAs require that the source code of the applicable component be disclosed as the condition for distributing the software component in executable format. You can check the software components subject to such EULA requirements on the following phone number:

Phone number: 1-800-631-3811

TOSHIBA provides a warranty for the TOSHIBA BD player you have purchased under conditions set forth by TOSHIBA.

However, some of the software components distributed under an EULA are made available for use by the user on the assumption that they are not copyrighted or warranted by TOSHIBA or any third party. These software components are licensed to the user free of charge and therefore not covered by any warranty within the scope of the applicable laws. These software components are not subject to any copyrights or other third-party rights and are provided in "as is" condition without any warranty, whether express or implied. "Warranty" here includes, but not limited to, an implied warranty for marketability or fitness for specific uses. All risks associated with the quality or performance of these software components are assumed by the user. TOSHIBA shall not be liable whatsoever for any cost of repair or correction or other incidental expense incurred in connection with a defect found in any of these software components. Unless specified under the applicable laws or in a written agreement, a party who changes or redistributes the software with consent from the copyright holders or based on the aforementioned licenses shall not be held liable whatsoever for any loss arising from the use of or inability to use such software components. The same applies even when the copyright holders or relevant third parties have been informed of the possibility of such loss. "Loss" here includes normal, special, incidental and indirect loss (including, but not limited to, the loss of data or its accuracy; loss incurred by the user or any third party; and interface incompatibility with other software). Please read each EULA for details on the use conditions and items that must be observed regarding these software components.

The table below lists the software components pre-installed in the TOSHIBA BD player, which are subject to EULAs. The user should read the applicable EULAs carefully before using these software components. The EULAs are exhibited in their original text (English) as exactly written by the respective parties other than TOSHIBA.

## Open-Source Third-party Software Included in the BD-Player (as of Feb 2010):

### Software License (\*= source must be distributed on request)

A copy of the GPL2.0 license is provided in Appendix K

A copy of the LGPL2.1 license is provided in Appendix L

<b>*backtrace</b>	GPL2 (Included in DVD 3.x [7630 systems] only)
<b>*directfb-extra</b>	GPL2
<b>*cairo</b>	LGPL2
<b>*directfb</b>	LGPL2
<b>*iconv</b>	LGPL2
<b>openssl</b>	BSD-old dual license. The terms and conditions which apply to this software are provided in Appendix H.  This product includes software developed by the OpenSSL Project for use in the OpenSSL Toolkit ( <a href="http://www.openssl.org">http://www.openssl.org</a> )
<b>curl</b>	The terms and conditions which apply to this software are provided in Appendix A.
<b>*freetype</b>	The terms and conditions which apply to this software are provided in Appendix G.  Recommended advertisement is:  Portions of this software are copyright © <year> The FreeType Project ( <a href="http://www.freetype.org">www.freetype.org</a> ). All rights reserved.
<b>jpeg</b>	The terms and conditions which apply to this software are provided in Appendix B.
<b>expat</b>	The terms and conditions which apply to this software are provided in Appendix I.
<b>mng</b>	The terms and conditions which apply to this software are provided in Appendix C.
<b>png</b>	The terms and conditions which apply to this software are provided in Appendix D.
<b>xml</b>	The terms and conditions which apply to this software are provided in Appendix E.
<b>zlib</b>	The terms and conditions which apply to this software are provided in Appendix F.

## Open-Source Third-party Software Included in the Kernel/Rootfs: (as of Feb 2010)

(\*= source must be distributed on request)

A copy of the GPL license is provided in Appendix K

A copy of the LGPL license is provided in Appendix L

Utility	Base Version	License
<b>*kernel</b>		GPL 2.0
<b>*arp</b>	net-tools-1.52	GPL 2.0
<b>*bash</b>	GNU Bash-3.2	GPL 2.0
<b>*busybox</b>	busybox-1.11.1	GPL 2.0
<b>*cramfsck</b>	cramfs	GPL 2.0
<b>*dhcpcd</b>	dhcpcd-1.3	GPL 2.0
<b>*e2fsprogs</b>	e2fsprogs-1.41.5	GPL 2.0
<b>*fdisk</b>	fdisk-2.10m	GPL 2.0
<b>*getty</b>	TinyLogin-0.80	GPL 2.0
<b>*hostnamesysutils</b>	sysutils	GPL 2.0
<b>*ifconfig</b>	net-tools-1.52	GPL 2.0
<b>*iptables</b>	iptables-1.4.3	GPL 2.0
<b>*kill</b>	sysutils	GPL 2.0
<b>*mkcramfs</b>	cramfs	GPL 2.0

<b>*mtd-utils</b>	mtd-utils-20090511	GPL 2.0
<b>*ntfs-3g</b>	ntfs-3g 2009.4.4	GPL 2.0
<b>*passwd</b>	TinyLogin-0.80	GPL 2.0
<b>*ps</b>	sysutils	GPL 2.0
<b>*route</b>	net-tools-1.52	GPL 2.0
<b>*sfdisk</b>	sfdisk-3.07	GPL 2.0
<b>*shutdown</b>	sysutils	GPL 2.0
<b>*tinylogin</b>	TinyLogin-0.80	GPL 2.0
<b>*hotplug</b>	hotplug-1.8	GPL 2.0
<b>*utelnetaid</b>	utelnetaid-0.1.3	GPL 2.0
<b>*procps</b>	procps-3.2.8	GPL 2.0
<b>*libfreetype.so.6.3.</b>	freetype-2.1.2	GPL 2.0
<b>*libtermcap.so</b>	GNU Bash-2.05	GPL 2.0
<b>*libtermcap.so.2.0.8</b>	GNU termcap 1.3	GPL 2.0
<b>zlib</b>	zlib-1.2.3	zlib license

The terms and conditions which apply to this software are provided in Appendix F.

<b>libusb.so</b>	libusb-0.1.12	LGPL 2.1
<b>uClibc</b>	uClibc-nptl-0.9.29-20070423	LGPL 2.1
<b>tcpdump</b>	tcpdump-4.0.0	BSD-new

The terms and conditions which apply to this software are provided in Appendix M.

<b>strace</b>	strace 4.5.18	BSD-new
---------------	---------------	---------

The terms and conditions which apply to this software are provided in Appendix M.

<b>hdparm</b>	hdparm-6.9	BSD-new
---------------	------------	---------

The terms and conditions which apply to this software are provided in Appendix M.

<b>libpcap</b>	libpcap-1.0.0	BSD-new
----------------	---------------	---------

The terms and conditions which apply to this software are provided in Appendix M.

<b>portmap</b>	portmap	BSD-old
----------------	---------	---------

The terms and conditions which apply to this software are provided in Appendix J.

Advertising sentence is:

Copyright (c) 1990 The Regents of the University of California. All rights reserved.

<b>openssl</b>	openssl 0.9.8k	BSD-old. See advertisement notice above.
----------------	----------------	--

Others

## Luxi Font Copyright

Luxi fonts copyright (c) 2001 by Bigelow & Holmes Inc. Luxi font instruction code copyright (c) 2001 by URW++ GmbH. All Rights Reserved. Luxi is a registered trademark of Bigelow & Holmes Inc. Permission is hereby granted, free of charge, to any person obtaining a copy of these Fonts and associated documentation files (the "Font Software"), to deal in the Font Software, including without limitation the rights to use, copy, merge, publish, distribute, sublicense, and/or sell copies of the Font Software, and to permit persons to whom the Font Software is furnished to do so, subject to the following conditions:

The above copyright and trademark notices and this permission notice shall be included in all copies of one or more of the Font Software.

The Font Software may not be modified, altered, or added to, and in particular the designs of glyphs or characters in the Fonts may not be modified nor may additional glyphs or characters be added to the Fonts. This License becomes null and void when the Fonts or Font Software have been modified.

THE FONT SOFTWARE IS PROVIDED "AS IS", WITHOUT WARRANTY OF ANY KIND, EXPRESS OR IMPLIED, INCLUDING BUT NOT LIMITED TO ANY WARRANTIES OF MERCHANTABILITY, FITNESS FOR A PARTICULAR PURPOSE AND NONINFRINGEMENT OF COPYRIGHT, PATENT, TRADEMARK, OR OTHER RIGHT. IN NO EVENT SHALL BIGELOW & HOLMES INC. OR URW++ GMBH. BE LIABLE FOR ANY CLAIM, DAMAGES OR OTHER LIABILITY, INCLUDING ANY GENERAL, SPECIAL, INDIRECT, INCIDENTAL, OR CONSEQUENTIAL DAMAGES, WHETHER IN AN ACTION OF CONTRACT, TORT OR OTHERWISE, ARISING FROM, OUT OF THE USE OR INABILITY TO USE THE FONT SOFTWARE OR FROM OTHER DEALINGS IN THE FONT SOFTWARE.

Except as contained in this notice, the names of Bigelow & Holmes Inc. and URW++ GmbH. shall not be used in advertising or otherwise to promote the sale, use or other dealings in this Font Software without prior written authorization from Bigelow & Holmes Inc. and URW++ GmbH.

For further information, contact:

info@urwpp.de or design@bigelowandholmes.com

### Appendix A - CURL license

#### COPYRIGHT AND PERMISSION NOTICE

Copyright (c) 1996 - 2009, Daniel Stenberg, <daniel@haxx.se>.

All rights reserved.

Permission to use, copy, modify, and distribute this software for any purpose with or without fee is hereby granted, provided that the above copyright notice and this permission notice appear in all copies.

THE SOFTWARE IS PROVIDED „AS IS“, WITHOUT WARRANTY OF ANY KIND, EXPRESS OR IMPLIED, INCLUDING BUT NOT LIMITED TO THE WARRANTIES OF MERCHANTABILITY, FITNESS FOR A PARTICULAR PURPOSE AND NONINFRINGEMENT OF THIRD PARTY RIGHTS. IN NO EVENT SHALL THE AUTHORS OR COPYRIGHT HOLDERS BE LIABLE FOR ANY CLAIM, DAMAGES OR OTHER LIABILITY, WHETHER IN AN ACTION OF CONTRACT, TORT OR OTHERWISE, ARISING FROM, OUT OF OR IN CONNECTION WITH THE SOFTWARE OR THE USE OR OTHER DEALINGS IN THE SOFTWARE.

Except as contained in this notice, the name of a copyright holder shall not be used in advertising or otherwise to promote the sale, use or other dealings in this Software without prior written authorization of the copyright holder.

### Appendix B - JPEG License

#### LEGAL ISSUES

=====

In plain English:

1. We don't promise that this software works. (But if you find any bugs, please let us know!)
2. You can use this software for whatever you want. You don't have to pay us.
3. You may not pretend that you wrote this software. If you use it in a program, you must acknowledge somewhere in your documentation that you've used the IJG code.

In legalese:

The authors make NO WARRANTY or representation, either express or implied, with respect to this software, its quality, accuracy, merchantability, or fitness for a particular purpose. This software is provided "AS IS", and you, its user, assume the entire risk as to its quality and accuracy.

This software is copyright (C) 1991-1998, Thomas G. Lane.  
All Rights Reserved except as specified below.

Permission is hereby granted to use, copy, modify, and distribute this software (or portions thereof) for any purpose, without fee, subject to these conditions:

- (1) If any part of the source code for this software is distributed, then this README file must be included, with this copyright and no-warranty notice unaltered; and any additions, deletions, or changes to the original files must be clearly indicated in accompanying documentation.
- (2) If only executable code is distributed, then the accompanying documentation must state that "this software is based in part on the work of the Independent JPEG Group".
- (3) Permission for use of this software is granted only if the user accepts full responsibility for any undesirable consequences; the authors accept NO LIABILITY for damages of any kind.

These conditions apply to any software derived from or based on the IJG code, not just to the unmodified library. If you use our work, you ought to acknowledge us.

Permission is NOT granted for the use of any IJG author's name or company name in advertising or publicity relating to this software or products derived from it. This software may be referred to only as "the Independent JPEG Group's software".

We specifically permit and encourage the use of this software as the basis of commercial products, provided that all warranty or liability claims are assumed by the product vendor.

### Appendix C - MNG License

/\* \*\*\*\*\*

#### COPYRIGHT NOTICE:

Copyright (c) 2000 Gerard Juyn (gerard@libmng.com)

[You may insert additional notices after this sentence if you modify this source]

For the purposes of this copyright and license, "Contributing Authors" is defined as the following set of individuals:

Gerard Juyn

The MNG Library is supplied "AS IS". The Contributing Authors disclaim all warranties, expressed or implied, including, without limitation, the warranties of merchantability and of fitness for any purpose. The Contributing Authors assume no liability for direct, indirect, incidental, special, exemplary, or consequential damages, which may result from the use of the MNG Library, even if advised of the possibility of such damage.

Permission is hereby granted to use, copy, modify, and distribute this source code, or portions hereof, for any purpose, without fee, subject to the following restrictions:



- 
1. The origin of this source code must not be misrepresented; you must not claim that you wrote the original software.
  2. Altered versions must be plainly marked as such and must not be misrepresented as being the original source.
  3. This Copyright notice may not be removed or altered from any source or altered source distribution.

The Contributing Authors specifically permit, without fee, and encourage the use of this source code as a component to supporting the MNG and JNG file format in commercial products. If you use this source code in a product, acknowledgment would be highly appreciated.

Parts of this software have been adapted from the libpng package. Although this library supports all features from the PNG specification (as MNG descends from it) it does not require the libpng package. It does require the zlib library and optionally the IJG jpeg library, and/or the "little-cms" library by Marti Maria (depending on the inclusion of support for JNG and Full-Color-Management respectively).

This library's function is primarily to read and display MNG animations. It is not meant as a full-featured image-editing component! It does however offer creation and editing functionality at the chunk level. (future modifications may include some more support for creation and or editing)

\*/

## Appendix D - PNG License File Distribution Clause

The Contributing Authors and Group 42, Inc. specifically permit, without fee, and encourage the use of this source code as a component to supporting the PNG file format in commercial products. If you use this source code in a product, acknowledgment is not required but would be appreciated.

## Appendix E – XML License

Except where otherwise noted in the source code (e.g. the files hash.c, list.c and the trio files, which are covered by a similar licence but with different Copyright notices) all the files are:

Copyright (C) 1998-2003 Daniel Veillard. All Rights Reserved.

Permission is hereby granted, free of charge, to any person obtaining a copy of this software and associated documentation files (the "Software"), to deal in the Software without restriction, including without limitation the rights to use, copy, modify, merge, publish, distribute, sublicense, and/or sell copies of the Software, and to permit persons to whom the Software is furnished to do so, subject to the following conditions:

The above copyright notice and this permission notice shall be included in all copies or substantial portions of the Software.

THE SOFTWARE IS PROVIDED "AS IS", WITHOUT WARRANTY OF ANY KIND, EXPRESS OR IMPLIED, INCLUDING BUT NOT LIMITED TO THE WARRANTIES OF MERCHANTABILITY, FITNESS FOR A PARTICULAR PURPOSE AND NONINFRINGEMENT. IN NO EVENT SHALL THE DANIEL VEILLARD BE LIABLE FOR ANY CLAIM, DAMAGES OR OTHER LIABILITY, WHETHER IN AN ACTION OF CONTRACT, TORT OR OTHERWISE, ARISING FROM, OUT OF OR IN CONNECTION WITH THE SOFTWARE OR THE USE OR OTHER DEALINGS IN THE SOFTWARE.

Except as contained in this notice, the name of Daniel Veillard shall not be used in advertising or otherwise to promote the sale, use or other dealings in this Software without prior written authorization from him.

## Appendix F – zlib Distribution Conditions

This software is provided 'as-is', without any express or implied warranty. In no event will the authors be held liable for any damages arising from the use of this software.

Permission is granted to anyone to use this software for any purpose, including commercial applications, and to alter it and redistribute it freely, subject to the following restrictions:

1. The origin of this software must not be misrepresented; you must not claim that you wrote the original software. If you use this software in a product, an acknowledgment in the product documentation would be appreciated but is not required.
2. Altered source versions must be plainly marked as such, and must not be misrepresented as being the original software.
3. This notice may not be removed or altered from any source distribution.

Jean-loup Gailly      Mark Adler  
jloup@gzip.org      madler@alumni.caltech.edu

If you use the zlib library in a product, we would appreciate \*not\* receiving lengthy legal documents to sign. The sources are provided for free but without warranty of any kind. The library has been entirely written by Jean-loup Gailly and Mark Adler; it does not include third-party code.

If you redistribute modified sources, we would appreciate that you include in the file ChangeLog history information documenting your changes. Please read the FAQ for more information on the distribution of modified source versions.

## Appendix G – Freetype License

The FreeType Project LICENSE

2006-Jan-27

Copyright 1996-2002, 2006 by  
David Turner, Robert Wilhelm, and Werner Lemberg

### Introduction

The FreeType Project is distributed in several archive packages; some of them may contain, in addition to the FreeType font engine, various tools and contributions which rely on, or relate to, the FreeType Project.

This license applies to all files found in such packages, and which do not fall under their own explicit license. The license affects thus the FreeType font engine, the test programs, documentation and makefiles, at the very least.

This license was inspired by the BSD, Artistic, and IJG (Independent JPEG Group) licenses, which all encourage inclusion and use of free software in commercial and freeware products alike. As a consequence, its main points are that:

- o We don't promise that this software works. However, we will be interested in any kind of bug reports. ('as is' distribution)
- o You can use this software for whatever you want, in parts or full form, without having to pay us. ('royalty-free' usage)
- o You may not pretend that you wrote this software. If you use it, or only parts of it, in a program, you must acknowledge somewhere in your documentation that you have used the FreeType code. ('credits')

We specifically permit and encourage the inclusion of this software, with or without modifications, in commercial products. We disclaim all warranties covering The FreeType Project and assume no liability related to The FreeType Project.

Finally, many people asked us for a preferred form for a credit/disclaimer to use in compliance with this license. We thus encourage you to use the following text:

```

Portions of this software are copyright © <year> The FreeType Project (www.freetype.org). All rights reserved.

```

Please replace <year> with the value from the FreeType version you actually use.

### Legal Terms

#### 0. Definitions

Throughout this license, the terms 'package', 'FreeType Project', and 'FreeType archive' refer to the set of files originally distributed by the authors (David Turner, Robert Wilhelm, and Werner Lemberg) as the 'FreeType Project', be they named as alpha, beta or final release.

'You' refers to the licensee, or person using the project, where 'using' is a generic term including compiling the project's source code as well as linking it to form a 'program' or 'executable'. This program is referred to as 'a program using the FreeType engine'.

This license applies to all files distributed in the original FreeType Project, including all source code, binaries and documentation, unless otherwise stated in the file in its original, unmodified form as distributed in the original archive. If you are unsure whether or not a particular file is covered by this license, you must contact us to verify this.

The FreeType Project is copyright (C) 1996-2000 by David Turner, Robert Wilhelm, and Werner Lemberg. All rights reserved except as specified below.

#### 1. No Warranty

THE FREETYPE PROJECT IS PROVIDED 'AS IS' WITHOUT WARRANTY OF ANY KIND, EITHER EXPRESS OR IMPLIED, INCLUDING, BUT NOT LIMITED TO, WARRANTIES OF MERCHANTABILITY AND FITNESS FOR A PARTICULAR PURPOSE. IN NO EVENT WILL ANY OF THE AUTHORS OR COPYRIGHT HOLDERS BE LIABLE FOR ANY DAMAGES CAUSED BY THE USE OR THE INABILITY TO USE, OF THE FREETYPE PROJECT.

#### 2. Redistribution

This license grants a worldwide, royalty-free, perpetual and irrevocable right and license to use, execute, perform, compile, display, copy, create derivative works of, distribute and sublicense the FreeType Project (in both source and object code forms) and derivative works thereof for any purpose; and to authorize others to exercise some or all of the rights granted herein, subject to the following conditions:

- o Redistribution of source code must retain this license file ('FTL.TXT') unaltered; any additions, deletions or changes to the original files must be clearly indicated in accompanying documentation. The copyright notices of the unaltered, original files must be preserved in all copies of source files.
- o Redistribution in binary form must provide a disclaimer that states that the software is based in part of the work of the FreeType Team, in the distribution documentation. We also encourage you to put an URL to the FreeType web page in your documentation, though this isn't mandatory.

These conditions apply to any software derived from or based on the FreeType Project, not just the unmodified files. If you use our work, you must acknowledge us. However, no fee need be paid to us.

### 3. Advertising

Neither the FreeType authors and contributors nor you shall use the name of the other for commercial, advertising, or promotional purposes without specific prior written permission.

We suggest, but do not require, that you use one or more of the following phrases to refer to this software in your documentation or advertising materials: 'FreeType Project', 'FreeType Engine', 'FreeType library', or 'FreeType Distribution'.

As you have not signed this license, you are not required to accept it. However, as the FreeType Project is copyrighted material, only this license, or another one contracted with the authors, grants you the right to use, distribute, and modify it. Therefore, by using, distributing, or modifying the FreeType Project, you indicate that you understand and accept all the terms of this license.

### 4. Contacts

There are two mailing lists related to FreeType:

o freetype@nongnu.org

Discusses general use and applications of FreeType, as well as future and wanted additions to the library and distribution. If you are looking for support, start in this list if you haven't found anything to help you in the documentation.

o freetype-devel@nongnu.org

Discusses bugs, as well as engine internals, design issues, specific licenses, porting, etc.

Our home page can be found at

<http://www.freetype.org>

--- end of FTL.TXT ---

## Appendix H – Openssl License

### LICENSE ISSUES

The OpenSSL toolkit stays under a dual license, i.e. both the conditions of the OpenSSL License and the original SSLeay license apply to the toolkit.

See below for the actual license texts. Actually both licenses are BSD-style Open Source licenses. In case of any license issues related to OpenSSL, please contact [openssl-core@openssl.org](mailto:openssl-core@openssl.org).

### OpenSSL License

/\* =====

Copyright (c) 1998-2008 The OpenSSL Project. All rights reserved.

Redistribution and use in source and binary forms, with or without modification, are permitted provided that the following conditions are met:

1. Redistributions of source code must retain the above copyright notice, this list of conditions and the following disclaimer.
2. Redistributions in binary form must reproduce the above copyright notice, this list of conditions and the following disclaimer in the documentation and/or other materials provided with the distribution.
3. All advertising materials mentioning features or use of this software must display the following acknowledgment: "This product includes software developed by the OpenSSL Project for use in the OpenSSL Toolkit. (<http://www.openssl.org/>)"
4. The names "OpenSSL Toolkit" and "OpenSSL Project" must not be used to endorse or promote products derived from this software without prior written permission. For written permission, please contact [openssl-core@openssl.org](mailto:openssl-core@openssl.org).
5. Products derived from this software may not be called "OpenSSL" nor may "OpenSSL" appear in their names without prior written permission \* of the OpenSSL Project.
6. Redistributions of any form whatsoever must retain the following acknowledgment: "This product includes software developed by the OpenSSL Project for use in the OpenSSL Toolkit (<http://www.openssl.org/>)"

THIS SOFTWARE IS PROVIDED BY THE OpenSSL PROJECT "AS IS" AND ANY EXPRESSED OR IMPLIED WARRANTIES, INCLUDING, BUT NOT LIMITED TO, THE IMPLIED WARRANTIES OF MERCHANTABILITY AND FITNESS FOR A PARTICULAR PURPOSE ARE DISCLAIMED. IN NO EVENT SHALL THE OpenSSL PROJECT OR ITS CONTRIBUTORS BE LIABLE FOR ANY DIRECT, INDIRECT, INCIDENTAL, SPECIAL, EXEMPLARY, OR CONSEQUENTIAL DAMAGES (INCLUDING, BUT NOT LIMITED TO, PROCUREMENT OF SUBSTITUTE GOODS OR SERVICES; LOSS OF USE, DATA, OR PROFITS; OR BUSINESS INTERRUPTION) HOWEVER CAUSED AND ON ANY THEORY OF LIABILITY, WHETHER IN CONTRACT, STRICT LIABILITY, OR TORT (INCLUDING NEGLIGENCE OR OTHERWISE) ARISING IN ANY WAY OUT OF THE USE OF THIS SOFTWARE, EVEN IF ADVISED OF THE POSSIBILITY OF SUCH DAMAGE.

This product includes cryptographic software written by Eric Young ([ey@cryptsoft.com](mailto:ey@cryptsoft.com)). This product includes software written by Tim Hudson ([tjh@cryptsoft.com](mailto:tjh@cryptsoft.com)).

\*/

### Original SSLeay License

/\* Copyright (C) 1995-1998 Eric Young (eay@cryptsoft.com) All rights reserved.

This package is an SSL implementation written by Eric Young (eay@cryptsoft.com). The implementation was written so as to conform with Netscapes SSL.

This library is free for commercial and non-commercial use as long as the following conditions are aheared to. The following conditions apply to all code found in this distribution, be it the RC4, RSA, lhash, DES, etc., code; not just the SSL code. The SSL documentation included with this distribution is covered by the same copyright terms except that the holder is Tim Hudson (tjh@cryptsoft.com).

Copyright remains Eric Young's, and as such any Copyright notices in the code are not to be removed. If this package is used in a product, Eric Young should be given attribution as the author of the parts of the library used. This can be in the form of a textual message at program startup or in documentation (online or textual) provided with the package.

Redistribution and use in source and binary forms, with or without modification, are permitted provided that the following conditions are met:

1. Redistributions of source code must retain the copyright notice, this list of conditions and the following disclaimer.
2. Redistributions in binary form must reproduce the above copyright notice, this list of conditions and the following disclaimer in the documentation and/or other materials provided with the distribution.
3. All advertising materials mentioning features or use of this software must display the following acknowledgement: "This product includes cryptographic software written by Eric Young (eay@cryptsoft.com)"

The word 'cryptographic' can be left out if the rouines from the library being used are not cryptographic related :-).

4. If you include any Windows specific code (or a derivative thereof) from the apps directory (application code) you must include an acknowledgement: "This product includes software written by Tim Hudson (tjh@cryptsoft.com)"

THIS SOFTWARE IS PROVIDED BY ERIC YOUNG ``AS IS'' AND ANY EXPRESS OR IMPLIED WARRANTIES, INCLUDING, BUT NOT LIMITED TO, THE IMPLIED WARRANTIES OF MERCHANTABILITY AND FITNESS FOR A PARTICULAR PURPOSE ARE DISCLAIMED. IN NO EVENT SHALL THE AUTHOR OR CONTRIBUTORS BE LIABLE FOR ANY DIRECT, INDIRECT, INCIDENTAL, SPECIAL, EXEMPLARY, OR CONSEQUENTIAL DAMAGES (INCLUDING, BUT NOT LIMITED TO, PROCUREMENT OF SUBSTITUTE GOODS OR SERVICES; LOSS OF USE, DATA, OR PROFITS; OR BUSINESS INTERRUPTION) HOWEVER CAUSED AND ON ANY THEORY OF LIABILITY, WHETHER IN CONTRACT, STRICT LIABILITY, OR TORT (INCLUDING NEGLIGENCE OR OTHERWISE) ARISING IN ANY WAY OUT OF THE USE OF THIS SOFTWARE, EVEN IF ADVISED OF THE POSSIBILITY OF SUCH DAMAGE.

The licence and distribution terms for any publically available version or derivative of this code cannot be changed. i.e. this code cannot simply be copied and put under another distribution licence [including the GNU Public Licence.]

\*/

### Appendix I – Expat License

Copyright (c) 1998, 1999, 2000 Thai Open Source Software Center Ltd and Clark Cooper Copyright (c) 2001, 2002, 2003, 2004, 2005, 2006 Expat maintainers.

Permission is hereby granted, free of charge, to any person obtaining a copy of this software and associated documentation files (the "Software"), to deal in the Software without restriction, including without limitation the rights to use, copy, modify, merge, publish, distribute, sublicense, and/or sell copies of the Software, and to permit persons to whom the Software is furnished to do so, subject to the following conditions:

The above copyright notice and this permission notice shall be included in all copies or substantial portions of the Software.

THE SOFTWARE IS PROVIDED "AS IS", WITHOUT WARRANTY OF ANY KIND, EXPRESS OR IMPLIED, INCLUDING BUT NOT LIMITED TO THE WARRANTIES OF MERCHANTABILITY, FITNESS FOR A PARTICULAR PURPOSE AND NONINFRINGEMENT. IN NO EVENT SHALL THE AUTHORS OR COPYRIGHT HOLDERS BE LIABLE FOR ANY CLAIM, DAMAGES OR OTHER LIABILITY, WHETHER IN AN ACTION OF CONTRACT, TORT OR OTHERWISE, ARISING FROM, OUT OF OR IN CONNECTION WITH THE SOFTWARE OR THE USE OR OTHER DEALINGS IN THE SOFTWARE.

### Appendix J – Portmap License

/\*-

Copyright (c) 1990 The Regents of the University of California. All rights reserved.

Redistribution and use in source and binary forms, with or without modification, are permitted provided that the following conditions are met:

1. Redistributions of source code must retain the above copyright notice, this list of conditions and the following disclaimer.
2. Redistributions in binary form must reproduce the above copyright notice, this list of conditions and the following disclaimer in the documentation and/or other materials provided with the distribution.
3. All advertising materials mentioning features or use of this software must display the following acknowledgement: This product includes software developed by the University of California, Berkeley and its contributors.
4. Neither the name of the University nor the names of its contributors may be used to endorse or promote products derived from this software without specific prior written permission.

THIS SOFTWARE IS PROVIDED BY THE REGENTS AND CONTRIBUTORS ``AS IS'' AND ANY EXPRESS OR IMPLIED WARRANTIES, INCLUDING, BUT NOT LIMITED TO, THE IMPLIED WARRANTIES OF MERCHANTABILITY AND FITNESS FOR A PARTICULAR PURPOSE ARE DISCLAIMED. IN NO EVENT SHALL THE REGENTS OR CONTRIBUTORS BE LIABLE FOR ANY DIRECT, INDIRECT, INCIDENTAL, SPECIAL, EXEMPLARY, OR CONSEQUENTIAL DAMAGES (INCLUDING, BUT NOT LIMITED TO, PROCUREMENT OF SUBSTITUTE GOODS OR SERVICES; LOSS OF USE, DATA, OR PROFITS; OR BUSINESS INTERRUPTION) HOWEVER CAUSED AND ON ANY THEORY OF LIABILITY, WHETHER IN CONTRACT, STRICT LIABILITY, OR TORT (INCLUDING NEGLIGENCE OR OTHERWISE) ARISING IN ANY WAY OUT OF THE USE OF THIS SOFTWARE, EVEN IF ADVISED OF THE POSSIBILITY OF SUCH DAMAGE.

\*/

## Appendix K – GNU GPL 2.0

GNU GENERAL PUBLIC LICENSE  
Version 2, June 1991

Copyright (C) 1989, 1991 Free Software Foundation, Inc.  
51 Franklin Street, Fifth Floor, Boston, MA 02110-1301, USA

Everyone is permitted to copy and distribute verbatim copies of this license document, but changing it is not allowed.

### Preamble

The licenses for most software are designed to take away your freedom to share and change it. By contrast, the GNU General Public License is intended to guarantee your freedom to share and change free software--to make sure the software is free for all its users. This General Public License applies to most of the Free Software Foundation's software and to any other program whose authors commit to using it. (Some other Free Software Foundation software is covered by the GNU Lesser General Public License instead.) You can apply it to your programs, too.

When we speak of free software, we are referring to freedom, not price. Our General Public Licenses are designed to make sure that you have the freedom to distribute copies of free software (and charge for this service if you wish), that you receive source code or can get it if you want it, that you can change the software or use pieces of it in new free programs; and that you know you can do these things.

To protect your rights, we need to make restrictions that forbid anyone to deny you these rights or to ask you to surrender the rights. These restrictions translate to certain responsibilities for you if you distribute copies of the software, or if you modify it.

For example, if you distribute copies of such a program, whether gratis or for a fee, you must give the recipients all the rights that you have. You must make sure that they, too, receive or can get the source code. And you must show them these terms so they know their rights.

We protect your rights with two steps: (1) copyright the software, and (2) offer you this license which gives you legal permission to copy, distribute and/or modify the software.

Also, for each author's protection and ours, we want to make certain that everyone understands that there is no warranty for this free software. If the software is modified by someone else and passed on, we want its recipients to know that what they have is not the original, so that any problems introduced by others will not reflect on the original authors' reputations.

Finally, any free program is threatened constantly by software patents. We wish to avoid the danger that redistributors of a free program will individually obtain patent licenses, in effect making the program proprietary. To prevent this, we have made it clear that any patent must be licensed for everyone's free use or not licensed at all.

The precise terms and conditions for copying, distribution and modification follow.

### TERMS AND CONDITIONS FOR COPYING, DISTRIBUTION AND MODIFICATION

0. This License applies to any program or other work which contains a notice placed by the copyright holder saying it may be distributed under the terms of this General Public License. The "Program", below, refers to any such program or work, and a "work based on the Program" means either the Program or any derivative work under copyright law: that is to say, a work containing the Program or a portion of it, either verbatim or with modifications and/or translated into another language. (Hereinafter, translation is included without limitation in the term "modification".) Each licensee is addressed as "you".

Activities other than copying, distribution and modification are not covered by this License; they are outside its scope. The act of running the Program is not restricted, and the output from the Program is covered only if its contents constitute a work based on the Program (independent of having been made by running the Program). Whether that is true depends on what the Program does.

1. You may copy and distribute verbatim copies of the Program's source code as you receive it, in any medium, provided that you conspicuously and appropriately publish on each copy an appropriate copyright notice and disclaimer of warranty; keep intact all the notices that refer to this License and to the absence of any warranty; and give any other recipients of the Program a copy of this License along with the Program.

You may charge a fee for the physical act of transferring a copy, and you may at your option offer warranty protection in exchange for a fee.

2. You may modify your copy or copies of the Program or any portion of it, thus forming a work based on the Program, and copy and distribute such modifications or work under the terms of Section 1 above, provided that you also meet all of these conditions:

- a) You must cause the modified files to carry prominent notices stating that you changed the files and the date of any change.
- b) You must cause any work that you distribute or publish, that in whole or in part contains or is derived from the Program or any part thereof, to be licensed as a whole at no charge to all third parties under the terms of this License.
- c) If the modified program normally reads commands interactively when run, you must cause it, when started running for such interactive use in the most ordinary way, to print or display an announcement including an appropriate copyright notice and a notice that there is no warranty (or else, saying that you provide a warranty) and that users may redistribute the program under these conditions, and telling the user how to view a copy of this License. (Exception: if the Program itself is interactive but does not normally print such an announcement, your work based on the Program is not required to print an announcement.)

These requirements apply to the modified work as a whole. If identifiable sections of that work are not derived from the Program, and can be reasonably considered independent and separate works in themselves, then this License, and its terms, do not apply to those sections when you distribute them as separate works. But when you distribute the same sections as part of a whole which is a work based on the Program, the distribution of the whole must be on the terms of this License, whose permissions for other licensees extend to the entire whole, and thus to each and every part regardless of who wrote it.

Thus, it is not the intent of this section to claim rights or contest your rights to work written entirely by you; rather, the intent is to exercise the right to control the distribution of derivative or collective works based on the Program.

In addition, mere aggregation of another work not based on the Program with the Program (or with a work based on the Program) on a volume of a storage or distribution medium does not bring the other work under the scope of this License.

3. You may copy and distribute the Program (or a work based on it, under Section 2) in object code or executable form under the terms of Sections 1 and 2 above provided that you also do one of the following:

- a) Accompany it with the complete corresponding machine-readable source code, which must be distributed under the terms of Sections 1 and 2 above on a medium customarily used for software interchange; or,
- b) Accompany it with a written offer, valid for at least three years, to give any third party, for a charge no more than your cost of physically performing source distribution, a complete machine-readable copy of the corresponding source code, to be distributed under the terms of Sections 1 and 2 above on a medium customarily used for software interchange; or,

c) Accompany it with the information you received as to the offer to distribute corresponding source code. (This alternative is allowed only for noncommercial distribution and only if you received the program in object code or executable form with such an offer, in accord with Subsection b above.)

The source code for a work means the preferred form of the work for making modifications to it. For an executable work, complete source code means all the source code for all modules it contains, plus any associated interface definition files, plus the scripts used to control compilation and installation of the executable. However, as a special exception, the source code distributed need not include anything that is normally distributed (in either source or binary form) with the major components (compiler, kernel, and so on) of the operating system on which the executable runs, unless that component itself accompanies the executable.

If distribution of executable or object code is made by offering access to copy from a designated place, then offering equivalent access to copy the source code from the same place counts as distribution of the source code, even though third parties are not compelled to copy the source along with the object code.

4. You may not copy, modify, sublicense, or distribute the Program except as expressly provided under this License. Any attempt otherwise to copy, modify, sublicense or distribute the Program is void, and will automatically terminate your rights under this License. However, parties who have received copies, or rights, from you under this License will not have their licenses terminated so long as such parties remain in full compliance.

5. You are not required to accept this License, since you have not signed it. However, nothing else grants you permission to modify or distribute the Program or its derivative works. These actions are prohibited by law if you do not accept this License. Therefore, by modifying or distributing the Program (or any work based on the Program), you indicate your acceptance of this License to do so, and all its terms and conditions for copying, distributing or modifying the Program or works based on it.

6. Each time you redistribute the Program (or any work based on the Program), the recipient automatically receives a license from the original licensor to copy, distribute or modify the Program subject to these terms and conditions. You may not impose any further restrictions on the recipients' exercise of the rights granted herein. You are not responsible for enforcing compliance by third parties to this License.

7. If, as a consequence of a court judgment or allegation of patent infringement or for any other reason (not limited to patent issues), conditions are imposed on you (whether by court order, agreement or otherwise) that contradict the conditions of this License, they do not excuse you from the conditions of this License. If you cannot distribute so as to satisfy simultaneously your obligations under this License and any other pertinent obligations, then as a consequence you may not distribute the Program at all. For example, if a patent license would not permit royalty-free redistribution of the Program by all those who receive copies directly or indirectly through you, then the only way you could satisfy both it and this License would be to refrain entirely from distribution of the Program.

If any portion of this section is held invalid or unenforceable under any particular circumstance, the balance of the section is intended to apply and the section as a whole is intended to apply in other circumstances.

It is not the purpose of this section to induce you to infringe any patents or other property right claims or to contest validity of any such claims; this section has the sole purpose of protecting the integrity of the free software distribution system, which is implemented by public license practices. Many people have made generous contributions to the wide range of software distributed through that system in reliance on consistent application of that system; it is up to the author/donor to decide if he or she is willing to distribute software through any other system and a licensee cannot impose that choice.

This section is intended to make thoroughly clear what is believed to be a consequence of the rest of this License.

8. If the distribution and/or use of the Program is restricted in certain countries either by patents or by copyrighted interfaces, the original copyright holder who places the Program under this License may add an explicit geographical distribution limitation excluding those countries, so that distribution is permitted only in or among countries not thus excluded. In such case, this License incorporates the limitation as if written in the body of this License.

9. The Free Software Foundation may publish revised and/or new versions of the General Public License from time to time. Such new versions will be similar in spirit to the present version, but may differ in detail to address new problems or concerns.

Each version is given a distinguishing version number. If the Program specifies a version number of this License which applies to it and "any later version", you have the option of following the terms and conditions either of that version or of any later version published by the Free Software Foundation. If the Program does not specify a version number of this License, you may choose any version ever published by the Free Software Foundation.

10. If you wish to incorporate parts of the Program into other free programs whose distribution conditions are different, write to the author to ask for permission. For software which is copyrighted by the Free Software Foundation, write to the Free Software Foundation; we sometimes make exceptions for this. Our decision will be guided by the two goals of preserving the free status of all derivatives of our free software and of promoting the sharing and reuse of software generally.

#### NO WARRANTY

11. BECAUSE THE PROGRAM IS LICENSED FREE OF CHARGE, THERE IS NO WARRANTY FOR THE PROGRAM, TO THE EXTENT PERMITTED BY APPLICABLE LAW. EXCEPT WHEN OTHERWISE STATED IN WRITING THE COPYRIGHT HOLDERS AND/OR OTHER PARTIES PROVIDE THE PROGRAM "AS IS" WITHOUT WARRANTY OF ANY KIND, EITHER EXPRESSED OR IMPLIED, INCLUDING, BUT NOT LIMITED TO, THE IMPLIED WARRANTIES OF MERCHANTABILITY AND FITNESS FOR A PARTICULAR PURPOSE. THE ENTIRE RISK AS TO THE QUALITY AND PERFORMANCE OF THE PROGRAM IS WITH YOU. SHOULD THE PROGRAM PROVE DEFECTIVE, YOU ASSUME THE COST OF ALL NECESSARY SERVICING, REPAIR OR CORRECTION.

12. IN NO EVENT UNLESS REQUIRED BY APPLICABLE LAW OR AGREED TO IN WRITING WILL ANY COPYRIGHT HOLDER, OR ANY OTHER PARTY WHO MAY MODIFY AND/OR REDISTRIBUTE THE PROGRAM AS PERMITTED ABOVE, BE LIABLE TO YOU FOR DAMAGES, INCLUDING ANY GENERAL, SPECIAL, INCIDENTAL OR CONSEQUENTIAL DAMAGES ARISING OUT OF THE USE OR INABILITY TO USE THE PROGRAM (INCLUDING BUT NOT LIMITED TO LOSS OF DATA OR DATA BEING RENDERED INACCURATE OR LOSSES SUSTAINED BY YOU OR THIRD PARTIES OR A FAILURE OF THE PROGRAM TO OPERATE WITH ANY OTHER PROGRAMS), EVEN IF SUCH HOLDER OR OTHER PARTY HAS BEEN ADVISED OF THE POSSIBILITY OF SUCH DAMAGES.

END OF TERMS AND CONDITIONS

## Appendix L – GNU LGPL 2.1

### GNU LESSER GENERAL PUBLIC LICENSE

Version 2.1, February 1999

Copyright (C) 1991, 1999 Free Software Foundation, Inc.

59 Temple Place, Suite 330, Boston, MA 02111-1307 USA

Everyone is permitted to copy and distribute verbatim copies of this license document, but changing it is not allowed.

[This is the first released version of the Lesser GPL. It also counts as the successor of the GNU Library Public License, version 2, hence the version number 2.1.]

#### Preamble

The licenses for most software are designed to take away your freedom to share and change it. By contrast, the GNU General Public Licenses are intended to guarantee your freedom to share and change free software--to make sure the software is free for all its users.

This license, the Lesser General Public License, applies to some specially designated software packages--typically libraries--of the Free Software Foundation and other authors who decide to use it. You can use it too, but we suggest you first think carefully about whether this license or the ordinary General Public License is the better strategy to use in any particular case, based on the explanations below.

When we speak of free software, we are referring to freedom of use, not price. Our General Public Licenses are designed to make sure that you have the freedom to distribute copies of free software (and charge for this service if you wish); that you receive source code or can get it if you want it; that you can change the software and use pieces of it in new free programs; and that you are informed that you can do these things.

To protect your rights, we need to make restrictions that forbid distributors to deny you these rights or to ask you to surrender these rights. These restrictions translate to certain responsibilities for you if you distribute copies of the library or if you modify it.

For example, if you distribute copies of the library, whether gratis or for a fee, you must give the recipients all the rights that we gave you. You must make sure that they, too, receive or can get the source code. If you link other code with the library, you must provide complete object files to the recipients, so that they can relink them with the library after making changes to the library and recompiling it. And you must show them these terms so they know their rights.

We protect your rights with a two-step method: (1) we copyright the library, and (2) we offer you this license, which gives you legal permission to copy, distribute and/or modify the library.

To protect each distributor, we want to make it very clear that there is no warranty for the free library. Also, if the library is modified by someone else and passed on, the recipients should know that what they have is not the original version, so that the original author's reputation will not be affected by problems that might be introduced by others.

Finally, software patents pose a constant threat to the existence of any free program. We wish to make sure that a company cannot effectively restrict the users of a free program by obtaining a restrictive license from a patent holder. Therefore, we insist that any patent license obtained for a version of the library must be consistent with the full freedom of use specified in this license.

Most GNU software, including some libraries, is covered by the ordinary GNU General Public License. This license, the GNU Lesser General Public License, applies to certain designated libraries, and is quite different from the ordinary General Public License. We use this license for certain libraries in order to permit linking those libraries into non-free programs.

When a program is linked with a library, whether statically or using a shared library, the combination of the two is legally speaking a combined work, a derivative of the original library. The ordinary General Public License therefore permits such linking only if the entire combination fits its criteria of freedom. The Lesser General Public License permits more lax criteria for linking other code with the library.

We call this license the "Lesser" General Public License because it does Less to protect the user's freedom than the ordinary General Public License. It also provides other free software developers Less of an advantage over competing non-free programs. These disadvantages are the reason we use the ordinary General Public License for many libraries. However, the Lesser license provides advantages in certain special circumstances.

For example, on rare occasions, there may be a special need to encourage the widest possible use of a certain library, so that it becomes a de-facto standard. To achieve this, non-free programs must be allowed to use the library. A more frequent case is that a free library does the same job as widely used non-free libraries. In this case, there is little to gain by limiting the free library to free software only, so we use the Lesser General Public License.

In other cases, permission to use a particular library in non-free programs enables a greater number of people to use a large body of free software. For example, permission to use the GNU C Library in non-free programs enables many more people to use the whole GNU operating system, as well as its variant, the GNU/Linux operating system.

Although the Lesser General Public License is Less protective of the users' freedom, it does ensure that the user of a program that is linked with the Library has the freedom and the wherewithal to run that program using a modified version of the Library.

The precise terms and conditions for copying, distribution and modification follow. Pay close attention to the difference between a "work based on the library" and a "work that uses the library". The former contains code derived from the library, whereas the latter must be combined with the library in order to run.

#### GNU LESSER GENERAL PUBLIC LICENSE

#### TERMS AND CONDITIONS FOR COPYING, DISTRIBUTION AND MODIFICATION

0. This License Agreement applies to any software library or other program which contains a notice placed by the copyright holder or other authorized party saying it may be distributed under the terms of this Lesser General Public License (also called "this License"). Each licensee is addressed as "you".

A "library" means a collection of software functions and/or data prepared so as to be conveniently linked with application programs (which use some of those functions and data) to form executables.

The "Library", below, refers to any such software library or work which has been distributed under these terms. A "work based on the Library" means either the Library or any derivative work under copyright law: that is to say, a work containing the Library or a portion of it, either verbatim or with modifications and/or translated straightforwardly into another language. (Hereinafter, translation is included without limitation in the term "modification".)

"Source code" for a work means the preferred form of the work for making modifications to it. For a library, complete source code means all the source code for all modules it contains, plus any associated interface definition files, plus the scripts used to control compilation and installation of the library.

Activities other than copying, distribution and modification are not covered by this License; they are outside its scope. The act of running a program using the Library is not restricted, and output from such a program is covered only if its contents constitute a work based on the Library (independent of the use of the Library in a tool for writing it). Whether that is true depends on what the Library does and what the program that uses the Library does.

1. You may copy and distribute verbatim copies of the Library's complete source code as you receive it, in any medium, provided that you conspicuously and appropriately publish on each copy an appropriate copyright notice and disclaimer of warranty; keep intact all the notices that refer to this License and to the absence of any warranty; and distribute a copy of this License along with the Library.

You may charge a fee for the physical act of transferring a copy, and you may at your option offer warranty protection in exchange for a fee.

2. You may modify your copy or copies of the Library or any portion of it, thus forming a work based on the Library, and copy and distribute such modifications or work under the terms of Section 1 above, provided that you also meet all of these conditions:

- a) The modified work must itself be a software library.
- b) You must cause the files modified to carry prominent notices stating that you changed the files and the date of any change.
- c) You must cause the whole of the work to be licensed at no charge to all third parties under the terms of this License.
- d) If a facility in the modified Library refers to a function or a table of data to be supplied by an application program that uses the facility, other than as an argument passed when the facility is invoked, then you must make a good faith effort to ensure that, in the event an application does not supply such function or table, the facility still operates, and performs whatever part of its purpose remains meaningful.

(For example, a function in a library to compute square roots has a purpose that is entirely well-defined independent of the application. Therefore, Subsection 2d requires that any application-supplied function or table used by this function must be optional: if the application does not supply it, the square root function must still compute square roots.)

These requirements apply to the modified work as a whole. If identifiable sections of that work are not derived from the Library, and can be reasonably considered independent and separate works in themselves, then this License, and its terms, do not apply to those sections when you distribute them as separate works. But when you distribute the same sections as part of a whole which is a work based on the Library, the distribution of the whole must be on the terms of this License, whose permissions for other licensees extend to the entire whole, and thus to each and every part regardless of who wrote it.

Thus, it is not the intent of this section to claim rights or contest your rights to work written entirely by you; rather, the intent is to exercise the right to control the distribution of derivative or collective works based on the Library.

In addition, mere aggregation of another work not based on the Library with the Library (or with a work based on the Library) on a volume of a storage or distribution medium does not bring the other work under the scope of this License.

3. You may opt to apply the terms of the ordinary GNU General Public License instead of this License to a given copy of the Library. To do this, you must alter all the notices that refer to this License, so that they refer to the ordinary GNU General Public License, version 2, instead of to this License. (If a newer version than version 2 of the ordinary GNU General Public License has appeared, then you can specify that version instead if you wish.) Do not make any other change in these notices.

Once this change is made in a given copy, it is irreversible for that copy, so the ordinary GNU General Public License applies to all subsequent copies and derivative works made from that copy.

This option is useful when you wish to copy part of the code of the Library into a program that is not a library.

4. You may copy and distribute the Library (or a portion or derivative of it, under Section 2) in object code or executable form under the terms of Sections 1 and 2 above provided that you accompany it with the complete corresponding machine-readable source code, which must be distributed under the terms of Sections 1 and 2 above on a medium customarily used for software interchange.

If distribution of object code is made by offering access to copy from a designated place, then offering equivalent access to copy the source code from the same place satisfies the requirement to distribute the source code, even though third parties are not compelled to copy the source along with the object code.

5. A program that contains no derivative of any portion of the Library, but is designed to work with the Library by being compiled or linked with it, is called a "work that uses the Library". Such a work, in isolation, is not a derivative work of the Library, and therefore falls outside the scope of this License.

However, linking a "work that uses the Library" with the Library creates an executable that is a derivative of the Library (because it contains portions of the Library), rather than a "work that uses the library". The executable is therefore covered by this License. Section 6 states terms for distribution of such executables.

When a "work that uses the Library" uses material from a header file that is part of the Library, the object code for the work may be a derivative work of the Library even though the source code is not.

Whether this is true is especially significant if the work can be linked without the Library, or if the work is itself a library. The threshold for this to be true is not precisely defined by law.

If such an object file uses only numerical parameters, data structure layouts and accessors, and small macros and small inline functions (ten lines or less in length), then the use of the object file is unrestricted, regardless of whether it is legally a derivative work. (Executables containing this object code plus portions of the Library will still fall under Section 6.)

Otherwise, if the work is a derivative of the Library, you may distribute the object code for the work under the terms of Section 6. Any executables containing that work also fall under Section 6, whether or not they are linked directly with the Library itself.

6. As an exception to the Sections above, you may also combine or link a "work that uses the Library" with the Library to produce a work containing portions of the Library, and distribute that work under terms of your choice, provided that the terms permit modification of the work for the customer's own use and reverse engineering for debugging such modifications.

You must give prominent notice with each copy of the work that the Library is used in it and that the Library and its use are covered by this License. You must supply a copy of this License. If the work during execution displays copyright notices, you must include the copyright notice for the Library among them, as well as a reference directing the user to the copy of this License. Also, you must do one of these things:

- a) Accompany the work with the complete corresponding machine-readable source code for the Library including whatever changes were used in the work (which must be distributed under Sections 1 and 2 above); and, if the work is an executable linked with the Library, with the complete machine-readable "work that uses the Library", as object code and/or source code, so that the user can modify the Library and then relink to produce a modified executable containing the modified Library. (It is understood that the user who changes the contents of definitions files in the Library will not necessarily be able to recompile the application to use the modified definitions.)
- b) Use a suitable shared library mechanism for linking with the Library. A suitable mechanism is one that (1) uses at run time a copy of the library already present on the user's computer system, rather than copying library functions into the executable, and (2) will operate properly with a modified version of the library, if the user installs one, as long as the modified version is interface-compatible with the version that the work was made with.



- c) Accompany the work with a written offer, valid for at least three years, to give the same user the materials specified in Subsection 6a, above, for a charge no more than the cost of performing this distribution.
- d) If distribution of the work is made by offering access to copy from a designated place, offer equivalent access to copy the above specified materials from the same place.
- e) Verify that the user has already received a copy of these materials or that you have already sent this user a copy.

For an executable, the required form of the "work that uses the Library" must include any data and utility programs needed for reproducing the executable from it. However, as a special exception, the materials to be distributed need not include anything that is normally distributed (in either source or binary form) with the major components (compiler, kernel, and so on) of the operating system on which the executable runs, unless that component itself accompanies the executable.

It may happen that this requirement contradicts the license restrictions of other proprietary libraries that do not normally accompany the operating system. Such a contradiction means you cannot use both them and the Library together in an executable that you distribute.

7. You may place library facilities that are a work based on the Library side-by-side in a single library together with other library facilities not covered by this License, and distribute such a combined library, provided that the separate distribution of the work based on the Library and of the other library facilities is otherwise permitted, and provided that you do these two things:

- a) Accompany the combined library with a copy of the same work based on the Library, uncombined with any other library facilities. This must be distributed under the terms of the Sections above.
- b) Give prominent notice with the combined library of the fact that part of it is a work based on the Library, and explaining where to find the accompanying uncombined form of the same work.

8. You may not copy, modify, sublicense, link with, or distribute the Library except as expressly provided under this License. Any attempt otherwise to copy, modify, sublicense, link with, or distribute the Library is void, and will automatically terminate your rights under this License. However, parties who have received copies, or rights, from you under this License will not have their licenses terminated so long as such parties remain in full compliance.

9. You are not required to accept this License, since you have not signed it. However, nothing else grants you permission to modify or distribute the Library or its derivative works. These actions are prohibited by law if you do not accept this License. Therefore, by modifying or distributing the Library (or any work based on the Library), you indicate your acceptance of this License to do so, and all its terms and conditions for copying, distributing or modifying the Library or works based on it.

10. Each time you redistribute the Library (or any work based on the Library), the recipient automatically receives a license from the original licensor to copy, distribute, link with or modify the Library subject to these terms and conditions. You may not impose any further restrictions on the recipients' exercise of the rights granted herein. You are not responsible for enforcing compliance by third parties with this License.

11. If, as a consequence of a court judgment or allegation of patent infringement or for any other reason (not limited to patent issues), conditions are imposed on you (whether by court order, agreement or otherwise) that contradict the conditions of this License, they do not excuse you from the conditions of this License. If you cannot distribute so as to satisfy simultaneously your obligations under this License and any other pertinent obligations, then as a consequence you may not distribute the Library at all. For example, if a patent license would not permit royalty-free redistribution of the Library by all those who receive copies directly or indirectly through you, then the only way you could satisfy both it and this License would be to refrain entirely from distribution of the Library.

If any portion of this section is held invalid or unenforceable under any particular circumstance, the balance of the section is intended to apply, and the section as a whole is intended to apply in other circumstances.

It is not the purpose of this section to induce you to infringe any patents or other property right claims or to contest validity of any such claims; this section has the sole purpose of protecting the integrity of the free software distribution system which is implemented by public license practices. Many people have made generous contributions to the wide range of software distributed through that system in reliance on consistent application of that system; it is up to the author/donor to decide if he or she is willing to distribute software through any other system and a licensee cannot impose that choice.

This section is intended to make thoroughly clear what is believed to be a consequence of the rest of this License.

12. If the distribution and/or use of the Library is restricted in certain countries either by patents or by copyrighted interfaces, the original copyright holder who places the Library under this License may add an explicit geographical distribution limitation excluding those countries, so that distribution is permitted only in or among countries not thus excluded. In such case, this License incorporates the limitation as if written in the body of this License.

13. The Free Software Foundation may publish revised and/or new versions of the Lesser General Public License from time to time. Such new versions will be similar in spirit to the present version, but may differ in detail to address new problems or concerns.

Each version is given a distinguishing version number. If the Library specifies a version number of this License which applies to it and "any later version", you have the option of following the terms and conditions either of that version or of any later version published by the Free Software Foundation. If the Library does not specify a license version number, you may choose any version ever published by the Free Software Foundation.

14. If you wish to incorporate parts of the Library into other free programs whose distribution conditions are incompatible with these, write to the author to ask for permission. For software which is copyrighted by the Free Software Foundation, write to the Free Software Foundation; we sometimes make exceptions for this. Our decision will be guided by the two goals of preserving the free status of all derivatives of our free software and of promoting the sharing and reuse of software generally.

#### NO WARRANTY

15. BECAUSE THE LIBRARY IS LICENSED FREE OF CHARGE, THERE IS NO WARRANTY FOR THE LIBRARY, TO THE EXTENT PERMITTED BY APPLICABLE LAW. EXCEPT WHEN OTHERWISE STATED IN WRITING THE COPYRIGHT HOLDERS AND/OR OTHER PARTIES PROVIDE THE LIBRARY "AS IS" WITHOUT WARRANTY OF ANY KIND, EITHER EXPRESSED OR IMPLIED, INCLUDING, BUT NOT LIMITED TO, THE IMPLIED WARRANTIES OF MERCHANTABILITY AND FITNESS FOR A PARTICULAR PURPOSE. THE ENTIRE RISK AS TO THE QUALITY AND PERFORMANCE OF THE LIBRARY IS WITH YOU. SHOULD THE LIBRARY PROVE DEFECTIVE, YOU ASSUME THE COST OF ALL NECESSARY SERVICING, REPAIR OR CORRECTION.

16. IN NO EVENT UNLESS REQUIRED BY APPLICABLE LAW OR AGREED TO IN WRITING WILL ANY COPYRIGHT HOLDER, OR ANY OTHER PARTY WHO MAY MODIFY AND/OR REDISTRIBUTE THE LIBRARY AS PERMITTED ABOVE, BE LIABLE TO YOU FOR DAMAGES, INCLUDING ANY GENERAL, SPECIAL, INCIDENTAL OR CONSEQUENTIAL DAMAGES ARISING OUT OF THE USE OR INABILITY TO USE THE LIBRARY (INCLUDING BUT NOT LIMITED TO LOSS OF DATA OR DATA BEING RENDERED INACCURATE OR LOSSES SUSTAINED BY YOU OR THIRD PARTIES OR A FAILURE OF THE LIBRARY TO OPERATE WITH ANY OTHER SOFTWARE), EVEN IF SUCH HOLDER OR OTHER PARTY HAS BEEN ADVISED OF THE POSSIBILITY OF SUCH DAMAGES.

END OF TERMS AND CONDITIONS

## How to Apply These Terms to Your New Libraries

If you develop a new library, and you want it to be of the greatest possible use to the public, we recommend making it free software that everyone can redistribute and change. You can do so by permitting redistribution under these terms (or, alternatively, under the terms of the ordinary General Public License).

To apply these terms, attach the following notices to the library. It is safest to attach them to the start of each source file to most effectively convey the exclusion of warranty; and each file should have at least the "copyright" line and a pointer to where the full notice is found.

<one line to give the library's name and a brief idea of what it does.>

Copyright (C) <year> <name of author>

This library is free software; you can redistribute it and/or modify it under the terms of the GNU Lesser General Public License as published by the Free Software Foundation; either version 2.1 of the License, or (at your option) any later version.

This library is distributed in the hope that it will be useful, but WITHOUT ANY WARRANTY; without even the implied warranty of MERCHANTABILITY or FITNESS FOR A PARTICULAR PURPOSE. See the GNU Lesser General Public License for more details.

You should have received a copy of the GNU Lesser General Public License along with this library; if not, write to the Free Software Foundation, Inc., 59 Temple Place, Suite 330, Boston, MA 02111-1307 USA

Also add information on how to contact you by electronic and paper mail. You should also get your employer (if you work as a programmer) or your school, if any, to sign a "copyright disclaimer" for the library, if necessary. Here is a sample; alter the names:

Yoyodyne, Inc., hereby disclaims all copyright interest in the library `Frob' (a library for tweaking knobs) written by James Random Hacker.

<signature of Ty Coon>, 1 April 1990

Ty Coon, President of Vice

That's all there is to it!

## Appendix M – BSD-New

/\*

Copyright (c) 1988, 1989, 1990, 1991, 1992, 1993, 1994, 1995, 1996, 1997

The Regents of the University of California. All rights reserved.

Redistribution and use in source and binary forms, with or without modification, are permitted provided that: (1) source code distributions retain the above copyright notice and this paragraph in its entirety, (2) distributions including binary code include the above copyright notice and this paragraph in its entirety in the documentation or other materials provided with the distribution, and (3) all advertising materials mentioning features or use of this software display the following acknowledgement:

``This product includes software developed by the University of California, Lawrence Berkeley Laboratory and its contributors." Neither the name of the University nor the names of its contributors may be used to endorse or promote products derived from this software without specific prior written permission.

THIS SOFTWARE IS PROVIDED ``AS IS" AND WITHOUT ANY EXPRESS OR IMPLIED WARRANTIES, INCLUDING, WITHOUT LIMITATION, THE IMPLIED WARRANTIES OF MERCHANTABILITY AND FITNESS FOR A PARTICULAR PURPOSE.

\*/

## Appendix N – CinemaNow

### Third Party Requirements

#### a. gSOAP.

The following notice is applicable to the CinemaNow SDK. Company is required to include such notice in the documentation for any Embedded Products it distributes.

Part of the software embedded in this product is gSOAP software.

Portions created by gSOAP are Copyright (C) 2001-2004 Robert A. van Engelen, Genivia Inc. All Rights Reserved.

THE SOFTWARE IN THIS PRODUCT WAS IN PART PROVIDED BY GENIVIA INC AND ANY EXPRESS OR IMPLIED WARRANTIES, INCLUDING, BUT NOT LIMITED TO, THE IMPLIED WARRANTIES OF MERCHANTABILITY AND FITNESS FOR A PARTICULAR PURPOSE ARE DISCLAIMED. IN NO EVENT SHALL THE AUTHOR BE LIABLE FOR ANY DIRECT, INDIRECT, INCIDENTAL, SPECIAL, EXEMPLARY, OR CONSEQUENTIAL DAMAGES (INCLUDING, BUT NOT LIMITED TO, PROCUREMENT OF SUBSTITUTE GOODS OR SERVICES; LOSS OF USE, DATA, OR PROFITS; OR BUSINESS INTERRUPTION) HOWEVER CAUSED AND ON ANY THEORY OF LIABILITY, WHETHER IN CONTRACT, STRICT LIABILITY, OR TORT (INCLUDING NEGLIGENCE OR OTHERWISE) ARISING IN ANY WAY OUT OF THE USE OF THIS SOFTWARE, EVEN IF ADVISED OF THE POSSIBILITY OF SUCH DAMAGE.

#### b. [THE CODE IS BEING PROVIDED IN OBJECT CODE SO THE ABOVE DOESN'T APPLY]

#### c. Curl/ 7.12.2

COPYRIGHT AND PERMISSION NOTICE

Copyright (c) 1996 - 2009, Daniel Stenberg, <daniel@haxx.se>.

All rights reserved.

Permission to use, copy, modify, and distribute this software for any purpose with or without fee is hereby granted, provided that the above copyright notice and this permission notice appear in all copies.

THE SOFTWARE IS PROVIDED "AS IS", WITHOUT WARRANTY OF ANY KIND, EXPRESS OR IMPLIED, INCLUDING BUT NOT LIMITED TO THE WARRANTIES OF MERCHANTABILITY, FITNESS FOR A PARTICULAR PURPOSE AND NONINFRINGEMENT OF THIRD PARTY RIGHTS. IN NO EVENT SHALL THE AUTHORS OR COPYRIGHT HOLDERS BE LIABLE FOR ANY CLAIM, DAMAGES OR OTHER LIABILITY, WHETHER IN AN ACTION OF CONTRACT, TORT OR OTHERWISE, ARISING FROM, OUT OF OR IN CONNECTION WITH THE SOFTWARE OR THE USE OR OTHER DEALINGS IN THE SOFTWARE.

Except as contained in this notice, the name of a copyright holder shall not be used in advertising or otherwise to promote the sale, use or other dealings in this Software without prior written authorization of the copyright holder.

#### **d. C-ARES 1.6.0**

Copyright 1998 by the Massachusetts Institute of Technology.

Permission to use, copy, modify, and distribute this software and its documentation for any purpose and without fee is hereby granted, provided that the above copyright notice appear in all copies and that both that copyright notice and this permission notice appear in supporting documentation, and that the name of M.I.T. not be used in advertising or publicity pertaining to distribution of the software without specific, written prior permission. M.I.T. makes no representations about the suitability of this software for any purpose. It is provided "as is" without express or implied warranty.

#### **e. Openssl 0.9.5a**

Original SSLeay License

Copyright (C) 1995-1998 Eric Young (eay@cryptsoft.com) All rights reserved.

This package is an SSL implementation written by Eric Young (eay@cryptsoft.com). The implementation was written so as to conform with Netscapes SSL. This library is free for commercial and non-commercial use as long as the following conditions are adhered to. The following conditions apply to all code found in this distribution, be it the RC4, RSA, lhash, DES, etc., code; not just the SSL code. The SSL documentation included with this distribution is covered by the same copyright terms except that the holder is Tim Hudson (tjh@cryptsoft.com).

Copyright remains Eric Young's, and as such any Copyright notices in the code are not to be removed. If this package is used in a product, Eric Young should be given attribution as the author of the parts of the library used. This can be in the form of a textual message at program startup or in documentation (online or textual) provided with the package.

Redistribution and use in source and binary forms, with or without modification, are permitted provided that the following conditions are met:

1. Redistributions of source code must retain the copyright notice, this list of conditions and the following disclaimer.
2. Redistributions in binary form must reproduce the above copyright notice, this list of conditions and the following disclaimer in the documentation and/or other materials provided with the distribution.
3. All advertising materials mentioning features or use of this software must display the following acknowledgement: "This product includes cryptographic software written by Eric Young (eay@cryptsoft.com)" The word 'cryptographic' can be left out if the routines from the library being used are not cryptographic related :-).
4. If you include any Windows specific code (or a derivative thereof) from the apps directory (application code) you must include an acknowledgement: "This product includes software written by Tim Hudson (tjh@cryptsoft.com)"

THIS SOFTWARE IS PROVIDED BY ERIC YOUNG "AS IS" AND ANY EXPRESS OR IMPLIED WARRANTIES, INCLUDING, BUT NOT LIMITED TO, THE IMPLIED WARRANTIES OF MERCHANTABILITY AND FITNESS FOR A PARTICULAR PURPOSE ARE DISCLAIMED. IN NO EVENT SHALL THE AUTHOR OR CONTRIBUTORS BE LIABLE FOR ANY DIRECT, INDIRECT, INCIDENTAL, SPECIAL, EXEMPLARY, OR CONSEQUENTIAL DAMAGES (INCLUDING, BUT NOT LIMITED TO, PROCUREMENT OF SUBSTITUTE GOODS OR SERVICES; LOSS OF USE, DATA, OR PROFITS; OR BUSINESS INTERRUPTION) HOWEVER CAUSED AND ON ANY THEORY OF LIABILITY, WHETHER IN CONTRACT, STRICT LIABILITY, OR TORT (INCLUDING NEGLIGENCE OR OTHERWISE) ARISING IN ANY WAY OUT OF THE USE OF THIS SOFTWARE, EVEN IF ADVISED OF THE POSSIBILITY OF SUCH DAMAGE.

The license and distribution terms for any publicly available version or derivative of this code cannot be changed. i.e. this code cannot simply be copied and put under another distribution license [including the GNU Public License.]

Content owners use Windows Media digital rights management technology (WMDRM) to protect their intellectual property, including copyrights. This device uses WMDRM software to access WMDRM-protected content. If the WMDRM software fails to protect the content, content owners may ask Microsoft to revoke the software's ability to use WMDRM to play or copy protected content. Revocation does not affect unprotected content. When you download licenses for protected content, you agree that Microsoft may include a revocation list with the licenses. Content owners may require you to upgrade WMDRM to access their content. If you decline an upgrade, you will not be able to access content that requires the upgrade.



**TOSHIBA**